

DC FILTERING

FFLC

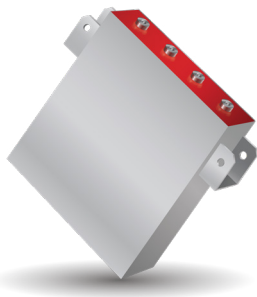

GENERAL DESCRIPTION

The FFLC series is specifically designed for DC filtering applications such as DC link or resonant filters.

Large case sizes up to 35 liters and high specific energy up to 240J/l together with safe and reliable **Controlled Self Healing Technology** make this series particularly suitable for power converters in traction, drives and renewable energy areas.

FFLC uses polypropylene metallized segmented film and it is fully dry technology.

Standard designs proposed in this catalogue are covering a wide range of voltage and capacitance.

STANDARDS

- IEC 61071: Power electronic capacitors
- IEC 61881: Railway applications, rolling stock equipment, capacitors for power electronics
- IEC 60068-2: Environmental testing
 - UL 94: Fire requirements
- NF F 16-101: Rolling stock – Fire behaviour – Materials choosing
- NF F 16-102: Rolling stock – Fire behaviour – Materials choosing, application for electric equipments
- EN 45545-2: Railways applications – Fire protection on railway vehicles Part 2 : Requirements for fire behaviour of materials and components

PACKAGING MATERIAL

- Non-painted rectangular resin filled aluminum case
- Mounting brackets
- 4 M8/15 Female connections or M12/30 Male connections

HOW TO ORDER

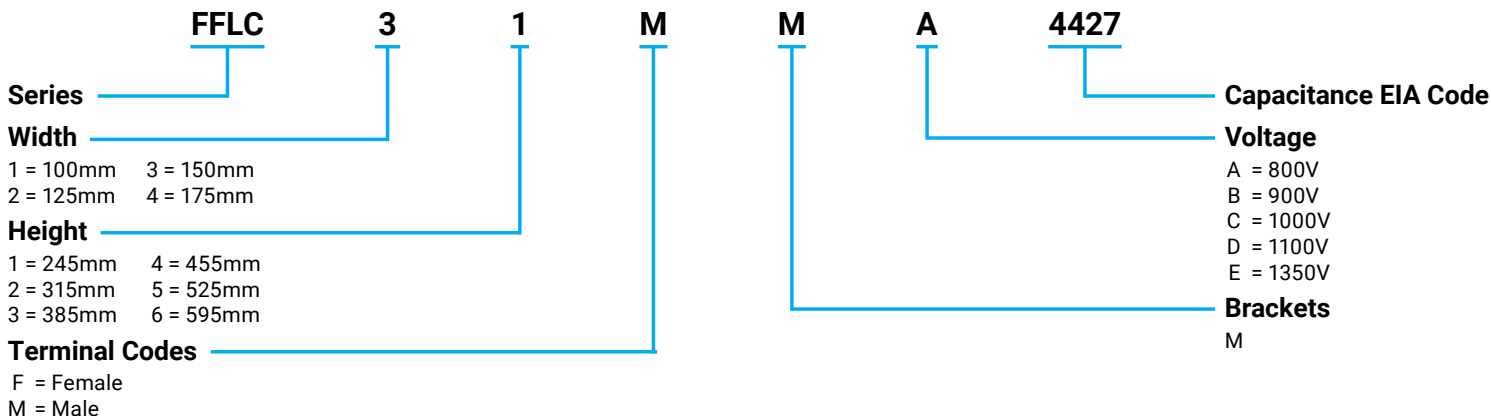

Архангельск (8182)63-90-72
Астана (7172)727-132
Астрахань (8512)99-46-04
Барнаул (3852)73-04-60
Белгород (4722)40-23-64
Брянск (4832)59-03-52
Владивосток (423)249-28-31
Волгоград (844)278-03-48
Вологда (8172)26-41-59
Воронеж (473)204-51-73
Екатеринбург (343)384-55-89
Иваново (4932)77-34-06

Ижевск (3412)26-03-58
Иркутск (395)279-98-46
Казань (843)206-01-48
Калининград (4012)72-03-81
Калуга (4842)92-23-67
Кемерово (3842)65-04-62
Киров (8332)68-02-04
Краснодар (861)203-40-90
Красноярск (391)204-63-61
Курск (4712)77-13-04
Липецк (4742)52-20-81
Киргизия (996)312-96-26-47

Магнитогорск (3519)55-03-13
Москва (495)268-04-70
Мурманск (8152)59-64-93
Набережные Челны (8552)20-53-41
Нижний Новгород (831)429-08-12
Новокузнецк (3843)20-46-81
Новосибирск (383)227-86-73
Омск (3812)21-46-40
Орел (4862)44-53-42
Оренбург (3532)37-68-04
Пенза (8412)22-31-16
Россия (495)268-04-70

Пермь (342)205-81-47
Ростов-на-Дону (863)308-18-15
Рязань (4912)46-61-64
Самара (846)206-03-16
Санкт-Петербург (812)309-46-40
Саратов (845)249-38-78
Севастополь (8692)22-31-93
Симферополь (3652)67-13-56
Смоленск (4812)29-41-54
Сочи (862)225-72-31
Ставрополь (8652)20-65-13
Казахстан (772)734-952-31

Сургут (3462)77-98-35
Тверь (4822)63-31-35
Томск (3822)98-41-53
Тула (4872)74-02-29
Тюмень (3452)66-21-18
Ульяновск (8422)24-23-59
Уфа (347)229-48-12
Хабаровск (4212)92-98-04
Челябинск (351)202-03-61
Череповец (8202)49-02-64
Ярославль (4852)69-52-93

DC FILTERING

FFLC

DEFINITIONS

C_n	capacitance	nominal value of the capacitance measured at $\theta_{amb} = 25 \pm 10^\circ\text{C}$
U_n	rated DC voltage	maximum operating peak voltage of either polarity (non-reversing type waveform), for which the capacitor has been designed for continuous operation
U_w	working voltage	value of the maximum operating recurrent voltage for a given hot spot temperature and an expected lifetime
U_r	ripple voltage	peak-to-peak alternating component of the unidirectional voltage
L_s	parasitic inductance	capacitor series self-inductance
R_s	capacitor series resistance	capacitor series resistance due to galvanic circuit
I_{rms}	thermal 1	RMS current value for continuous operation under natural convection generating 20°C overheating
I_{rms}	thermal 2	rms current value for continuous operation under forced air generating 20°C overheating
θ_{amb} ($^\circ\text{C}$)	cooling air temperature	temperature of the cooling air measured at the hottest position of the capacitor, under steady-state conditions, midway between two units NOTE If only one unit is involved, it is the temperature measured at a point approximately 0.1 m away from the capacitor container and at two-thirds of the height from its base
θ_{HS} ($^\circ\text{C}$)	hot spot temperature	highest temperature obtained inside the case of the capacitor in thermal equilibrium

CHARACTERISTICS

Capacitance range C_n	1750 μF to 20600 μF
Tolerance on C_n	$\pm 10\%$
Rated DC voltage U_n	800 to 1350V
Lifetime at U_n and 70°C hot-spot temperature and $\Delta C / C < 2\%$	100,000h
Parasitic inductance L_s	32 to 55nH
Maximum rms current I_{rms}	up to 400A _{rms}
Test voltage between terminals @ 25°C	$1.5 \times U_n$ for 10s
Test voltage between terminals and Case @ 25°C	4kV _{rms} @ 50Hz for 10s
Dielectric	polypropylene
Climatic Category	40 / 85 / 56 (IEC 60068)
Working temperature	$-40^\circ\text{C} / +85^\circ\text{C}$ (according to the power dissipated)
Storage temperature	$-40^\circ\text{C} / +85^\circ\text{C}$
Calorific value	27 MJ/kg

LIFETIME EXPECTANCY VS. HOT SPOT TEMPERATURE AND VOLTAGE

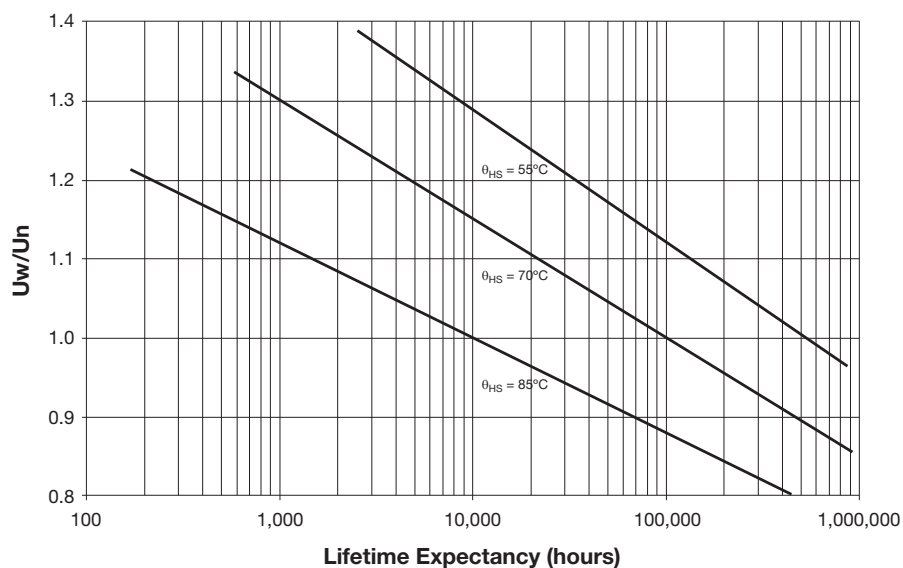

DC FILTERING

FFLC

HOW TO CHOSE THE RIGHT CAPACITOR

The capacitor lifetime depends on the working voltage and the hot spot temperature.

Our caps are designed to meet 100000 hours lifetime at rated voltage and 70°C hot spot temperature. In accordance with operating conditions, please calculate the hot spot temperature and deduce from this calculation if the obtained lifetime can suit the application.

1. From the tables, select a capacitor with required capacitance

C_n and voltage U_n .

Calculate the maximum ripple voltage allowed for the selected cap:

$$U_{rmax} = 0.2U_n$$

If $U_r > U_{rmax}$, select a capacitor with higher rated voltage

Make sure I_{rms} application $<$ I_{rms} table

Copy out:

- serial resistance (R_s): see table of values
- thermal resistances R_{th1} and R_{th2} (depending on cooling conditions)

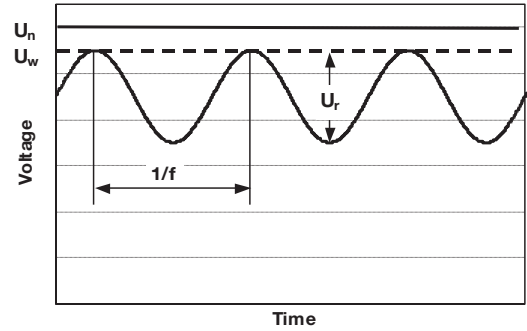

2. Hot spot temperature calculation

Total losses are calculated as follow: $P_t = P_j + P_d$

Joule losses: $P_j = R_s \times I_{rms}^2$

Dielectric losses: $P_d = Q \times \text{tg}\delta_0$ with

- Q (reactive power) = $\frac{I_{rms}^2}{C\omega}$ for a sinusoidal waveform

- $\text{tg}\delta_0 = 2 \times 10^{-4}$ (dielectric losses of polypropylene)

Hot spot temperature will be:

$$\theta_{HS} = \theta_{amb} + (P_j + P_d) \times (R_{th1} + R_{th2})$$

θ_{HS} **absolute maximum is 85°C**

If temperature is higher than 85°C, come back to #1 and start again with another selection.

R_{th1} : Thermal resistance between hot spot and case

R_{th2} : Thermal resistance between case and ambient air

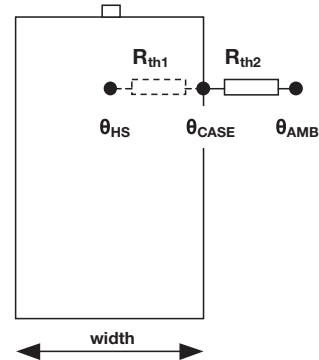

3. Refer to the curve and deduce the lifetime vs U_w/U_n ratio

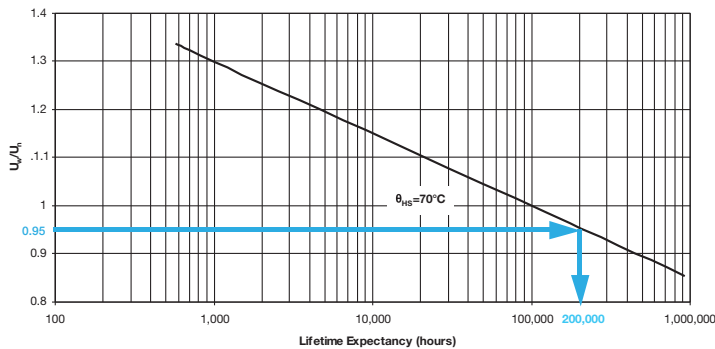

eg: rated voltage 1000V
 working voltage 950V
 $\rho = 0.95 \Rightarrow$ lifetime 200,000 hours
 @ 70°C hot spot temperature

Please, find a calculation form at the end of the catalog

DC FILTERING

FFLC

THERMAL RESISTANCES

R_{th1} (°C/W): Thermal resistance between hot spot and case

Height (mm)	R_{th1} (°C/W)			
	Width (mm)			
	100	125	150	175
245	0.56	0.67	0.76	0.82
315	0.41	0.49	0.56	0.6
385	0.3	0.36	0.41	0.44
455	0.25	0.3	0.34	0.37
525	0.2	0.24	0.27	0.3
595	0.17	0.21	0.24	0.26

R_{th2} (°C/W): Thermal resistance between case and ambient air under natural convection and forced air

Height (mm)	R_{th2} (°C)							
	Natural air cooling				Forced air cooling >2m/s			
	Width (mm)				Width (mm)			
	100	125	150	175	100	125	150	175
245	0.47	0.44	0.42	0.40	0.23	0.22	0.21	0.20
315	0.36	0.35	0.33	0.31	0.18	0.17	0.16	0.16
385	0.30	0.28	0.27	0.25	0.15	0.14	0.13	0.13
455	0.25	0.24	0.23	0.22	0.13	0.12	0.11	0.11
525	0.22	0.21	0.20	0.19	0.11	0.10	0.10	0.09
595	0.19	0.18	0.17	0.16	0.10	0.09	0.09	0.08



For confined area, capacitor working in a closed cabinet, a thermal test under real conditions is necessary to evaluate the thermal resistance.

PARASITIC INDUCTANCE VS SIZE

Measurement @ 1MHz

Height (mm)	L_s (nH)			
	Width (mm)			
	100	125	150	175
245	32	34	35	37
315	34	36	38	40
385	36	39	41	44
455	38	41	44	48
525	40	43	47	51
595	42	46	51	55

Low inductance design available on request

MTBF CALCULATION

Based on Return Of Experience from the field of more than 30 years, we have established the following relation.

$$\rho = U_w/U_n$$

$$\lambda_B = 3 \times 10^{2.75(\rho-1)} \times e^{\left(3.2 \left(\frac{0_{HS}+273}{358}\right)^{30}\right)} \times 10^{-9} \text{ in failures/hour}$$

GENERAL FAILURE RATE

$\lambda = \lambda_B \times \pi_Q \times \pi_B \times \pi_E$ failures/hour • π_Q , π_B and π_E see following tables

Qualification	Qualification factor π_Q
Product qualified on IEC61071 and internal qualification	1
Product qualified on IEC61071	2
Product answering on another norm	5
Product without qualification	15

Environment	Environment factor π_E
On ground (good conditions)	1
On ground (fixed materials)	2
On ground (on board)	4
On ship	9
On plane	15

Environment	Environment factor π_B
Favorable	1
Unfavourable	5

MEAN TIME BETWEEN FAILURE (MTBF)

MTBF = 1/ λ hours

SURVIVAL FUNCTION

$$N = N_0 \times \exp(-\lambda t)$$

N is the number of pieces still working after t hours.

N_0 is the number of pieces at the origin (t = 0)

FAILURE MODE

Main failure mode due to KYOCERA AVX's **Controlled Self-Healing Technology** is only losses of capacitance. Thanks to **Controlled Self-Healing solution** to interrupt self-healing process in order to prevent avalanche effect due to polypropylene molecular cracking producing gas and potential explosion in confined box for none **Controlled Self-Healing capacitors**.

DC FILTERING

FFLC

DIMENSIONS

Female terminals

(Max torque 15Nm)

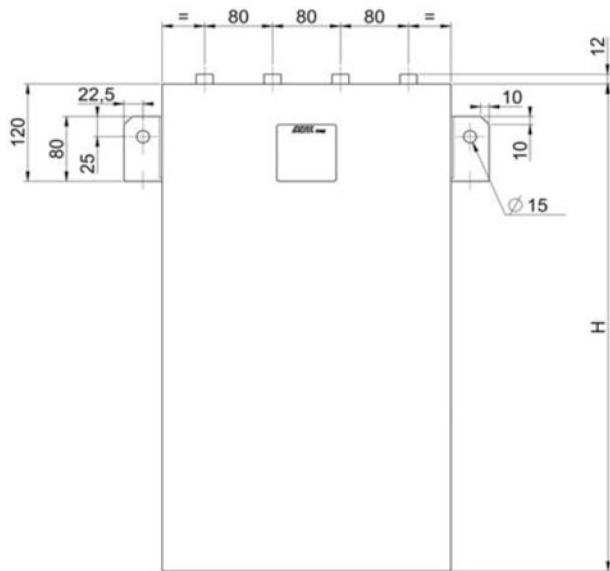

Female terminals

(Max torque 25Nm)

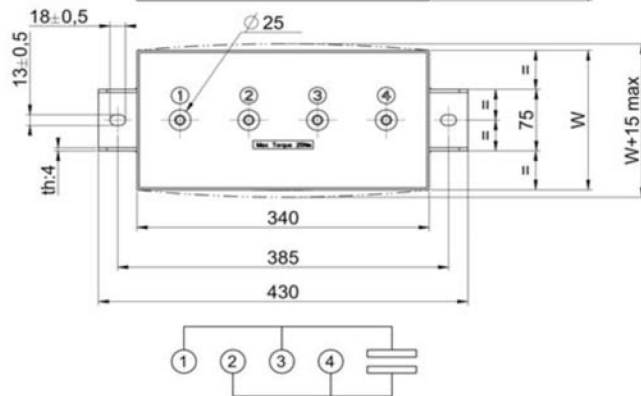
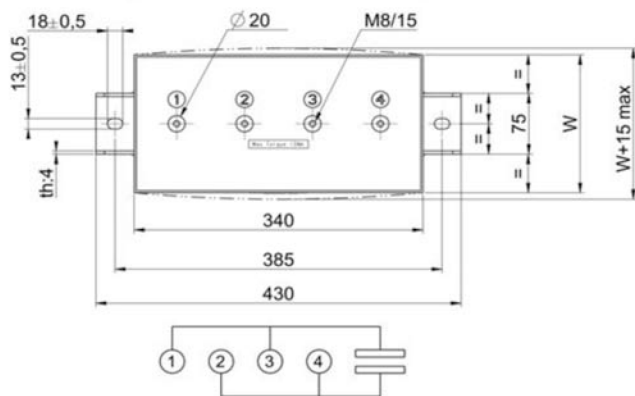
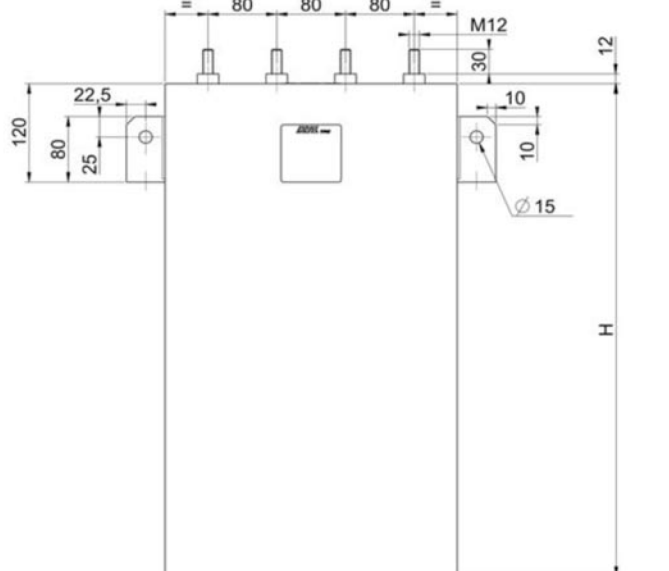

Available standard dimensions (other dimensions on request for specific design)

H (mm): 245, 315, 385, 455, 525 and 595

W (mm): 100, 125, 150 and 175

WEIGHT VS SIZE

mm

Height	Weight (kg)			
	Width			
	100	125	150	175
245	12	15	17.5	20.5
315	15	18.5	22.5	26
385	18.5	23	27.5	32
455	21.5	27	32.5	37.5
525	25	31.5	37.5	42.5
595	28.5	35	41.5	48.5

DC FILTERING

FFLC

TABLE OF VALUES

Part Number	Capacitance (μF)	Width (mm)	Height (mm)	R_s (m Ω)	I_{rms} Thermal 1 (A)	I_{rms} Thermal 2 (A)
$U_n = 800\text{Vdc}$						
FFLC11 * MA4777	4,770	100	245	0.27	270	306
FFLC12 * MA6087	6,080	100	315	0.23	333	380
FFLC21 * MA6557	6,550	125	245	0.29	249	276
FFLC13 * MA7817	7,810	100	385	0.20	400	400
FFLC31 * MA8317	8,310	150	245	0.32	231	255
FFLC22 * MA8337	8,330	125	315	0.25	310	348
FFLC14 * MA9117	9,110	100	455	0.19	400	400
FFLC41 * MA1008	10,000	175	245	0.35	218	240
FFLC32 * MA1068	10,600	150	315	0.27	288	320
FFLC23 * MA1078	10,700	125	385	0.22	380	400
FFLC15 * MA1098	10,900	100	525	0.17	400	400
FFLC16 * MA1228	12,200	100	595	0.17	400	400
FFLC24 * MA1258	12,500	125	455	0.20	400	400
FFLC42 * MA1278	12,700	175	315	0.29	274	299
FFLC33 * MA1368	13,600	150	385	0.23	355	395
FFLC25 * MA1498	14,900	125	525	0.18	400	400
FFLC34 * MA1598	15,900	150	455	0.21	400	400
FFLC43 * MA1648	16,400	175	385	0.25	338	374
FFLC26 * MA1678	16,700	125	595	0.22	400	400
FFLC35 * MA1898	18,900	150	525	0.20	400	400
FFLC44 * MA1918	19,100	175	455	0.23	385	400
FFLC36 * MA2118	21,100	150	595	0.19	400	400
FFLC45 * MA2288	22,800	175	525	0.21	400	400
FFLC46 * MA2558	25,500	175	595	0.20	400	400
$U_n = 900\text{Vdc}$						
FFLC11 * MB3847	3,840	100	245	0.29	261	296
FFLC12 * MB4897	4,890	100	315	0.25	323	368
FFLC21 * MB5277	5,270	125	245	0.31	240	267
FFLC13 * MB6287	6,280	100	385	0.21	310	400
FFLC31 * MB6707	6,700	150	245	0.34	222	245
FFLC22 * MB6717	6,710	125	315	0.27	300	337
FFLC14 * MB7337	7,330	100	455	0.20	400	400
FFLC41 * MB8077	8,070	175	245	0.37	209	231
FFLC32 * MB8537	8,530	150	315	0.29	278	309
FFLC23 * MB8627	8,620	125	385	0.23	369	400
FFLC15 * MB8737	8,730	100	525	0.18	400	400
FFLC16 * MB9777	9,770	100	595	0.17	400	400
FFLC24 * MB1018	10,100	125	455	0.21	400	400
FFLC42 * MB1038	10,300	175	315	0.32	264	289
FFLC33 * MB1108	11,000	150	385	0.25	344	383
FFLC25 * MB1258	12,500	125	525	0.19	400	400
FFLC34 * MB1288	12,800	150	455	0.23	393	400
FFLC43 * MB1328	13,200	175	385	0.27	327	362
FFLC26 * MB1348	13,400	125	595	0.18	400	400
FFLC35 * MB1528	15,200	150	525	0.21	400	400
FFLC44 * MB1548	15,400	175	455	0.24	373	400
FFLC36 * MB1718	17,100	150	595	0.20	400	400
FFLC45 * MB1848	18,400	175	525	0.22	400	400
FFLC46 * MB2068	20,600	175	595	0.21	400	400

* Insert F for female terminals or M for male terminals

DC FILTERING

FFLC

TABLE OF VALUES

Part Number	Capacitance (µF)	Width (mm)	Height (mm)	R _s (mΩ)	I _{rms} Thermal 1 (A)	I _{rms} Thermal 2 (A)
U_n = 1000Vdc						
FFLC11 * MC3167	3,160	100	245	0.30	253	287
FFLC12 * MC4027	4,020	100	315	0.26	314	358
FFLC21 * MC4337	4,330	125	245	0.33	232	258
FFLC13 * MC5177	5,170	100	385	0.23	385	400
FFLC31 * MC5517	5,510	150	245	0.37	215	237
FFLC22 * MC5527	5,520	125	315	0.28	291	326
FFLC14 * MC6037	6,030	100	455	0.21	400	400
FFLC41 * MC6647	6,640	175	245	0.40	202	223
FFLC32 * MC7017	7,010	150	315	0.31	269	299
FFLC23 * MC7097	7,090	125	385	0.24	358	400
FFLC15 * MC7187	7,180	100	525	0.19	400	400
FFLC16 * MC8047	8,040	100	595	0.18	400	400
FFLC24 * MC8277	8,270	125	455	0.22	400	400
FFLC42 * MC8467	8,460	175	315	0.34	255	279
FFLC33 * MC9027	9,020	150	385	0.26	334	372
FFLC25 * MC9857	9,850	125	525	0.20	400	400
FFLC34 * MC1058	10,500	150	455	0.24	382	400
FFLC43 * MC1098	10,900	175	385	0.29	317	351
FFLC26 * MC1108	11,000	125	595	0.19	400	400
FFLC35 * MC1258	12,500	150	525	0.22	400	400
FFLC44 * MC1278	12,700	175	455	0.26	362	400
FFLC36 * MC1408	14,000	150	595	0.21	400	400
FFLC45 * MC1518	15,100	175	525	0.23	400	400
FFLC46 * MC1698	16,900	175	595	0.22	400	400
U_n = 1100Vdc						
FFLC11 * MD2537	2,530	100	245	0.33	243	276
FFLC12 * MD3227	3,220	100	315	0.28	303	345
FFLC21 * MD3487	3,480	125	245	0.36	223	248
FFLC13 * MD4147	4,140	100	385	0.24	373	400
FFLC31 * MD4427	4,420	150	245	0.40	206	227
FFLC22 * MD4437	4,430	125	315	0.31	280	314
FFLC14 * MD4837	4,830	100	455	0.22	400	400
FFLC41 * MD5347	5,340	175	245	0.44	194	214
FFLC32 * MD5637	5,630	150	315	0.34	259	288
FFLC23 * MD5697	5,690	125	385	0.26	346	392
FFLC15 * MD5757	5,750	100	525	0.20	400	400
FFLC16 * MD6447	6,440	100	595	0.19	400	400
FFLC24 * MD6647	6,640	125	455	0.24	395	400
FFLC42 * MD6797	6,790	175	315	0.37	245	269
FFLC33 * MD7247	7,240	150	385	0.28	323	359
FFLC25 * MD7907	7,900	125	525	0.22	400	400
FFLC34 * MD8447	8,440	150	455	0.26	370	400
FFLC43 * MD8737	8,730	175	385	0.31	306	339
FFLC26 * MD8857	8,850	125	595	0.20	400	400
FFLC35 * MD1018	10,100	150	525	0.23	400	400
FFLC44 * MD1028	10,200	175	455	0.28	350	388
FFLC36 * MD1138	11,300	150	595	0.22	400	400
FFLC45 * MD1218	12,100	175	525	0.25	400	400
FFLC46 * MD1368	13,600	175	595	0.23	400	400

* Insert F for female terminals or M for male terminals

DC FILTERING

FFLC

TABLE OF VALUES

Part Number	Capacitance (μF)	Width (mm)	Height (mm)	R_s (m Ω)	I_{rms} Thermal 1 (A)	I_{rms} Thermal 2 (A)
$U_n = 1350\text{Vdc}$						
FFLC11 * ME1757	1,750	100	245	0.37	228	259
FFLC12 * ME2237	2,230	100	315	0.32	285	325
FFLC21 * ME2407	2,400	125	245	0.41	208	232
FFLC13 * ME2867	2,860	100	385	0.27	353	400
FFLC31 * ME3057	3,050	150	245	0.46	192	212
FFLC22 * ME3067	3,060	125	315	0.35	263	210
FFLC14 * ME3347	3,340	100	455	0.24	400	400
FFLC41 * ME3677	3,670	175	245	0.51	180	199
FFLC32 * ME3887	3,880	150	315	0.38	242	270
FFLC23 * ME3927	3,920	125	385	0.28	334	378
FFLC15 * ME3987	3,980	100	525	0.22	400	400
FFLC16 * ME4457	4,450	100	595	0.21	400	400
FFLC24 * ME4587	4,580	125	455	0.26	374	400
FFLC42 * ME4687	4,680	175	315	0.42	229	251
FFLC33 * ME4997	4,990	150	385	0.32	303	337
FFLC25 * ME5457	5,450	125	525	0.24	400	400
FFLC34 * ME5827	5,820	150	455	0.29	349	393
FFLC43 * ME6017	6,010	175	385	0.35	287	318
FFLC26 * ME6107	6,100	125	595	0.22	400	400
FFLC35 * ME6937	6,930	150	525	0.26	400	400
FFLC44 * ME7017	7,010	175	455	0.31	329	365
FFLC36 * ME7767	7,760	150	595	0.24	400	400
FFLC45 * ME8357	8,350	175	525	0.28	383	400
FFLC46 * ME9357	9,350	175	595	0.26	400	400

* Insert F for female terminals or M for male terminals

CALCULATION FORM SPECIFICATION

Capacitance	C (μF)	
Working voltage	U _w (V)	
Rms current	I _{rms} (Arms)	
Frequency	f (Hz)	
Ripple voltage	U _r (V)	
Ambient temperature	θ _{amb} (°C)	
Lifetime @ U _w , I _{rms} and θ _{amb}	hours	
Parasitic inductance	L (nH)	
Cooling conditions		

Your choice

PN		
Capacitance	C (μF)	
Rated voltage	U _n (V)	
Serial resistance	R _s (mΩ)	
Thermal resistance between hot spot and case	R _{th1} (°C/W)	
Thermal resistance between case and ambient air	R _{th2} (°C/W)	

CALCULATIONS

Maximum ripple voltage	U _{rmax} = 0.2 U _n	U _{rmax} =	V
------------------------	----------------------------------------	---------------------	---

The maximum ripple voltage of the selected capacitor must be in any case higher than the ripple voltage of your application

Ratio V _w /V _n	ρ = U _w /U _n	ρ =	
Joule losses	P _j = R _s I _{rms} ²	P _j =	W
Dielectric losses	P _d = Qxtgδ0=Qx 2.10 ⁻⁴	P _d =	W
Hot spot temperature	θ _{HS} = θ _{amb} + (P _j + P _d) × (R _{th1} + R _{th2})	θ _{HS} =	°C

The hot spot temperature must be in any case lower than 85°C

LIFETIME EXPECTANCY VS HOT SPOT TEMPERATURE AND VOLTAGE

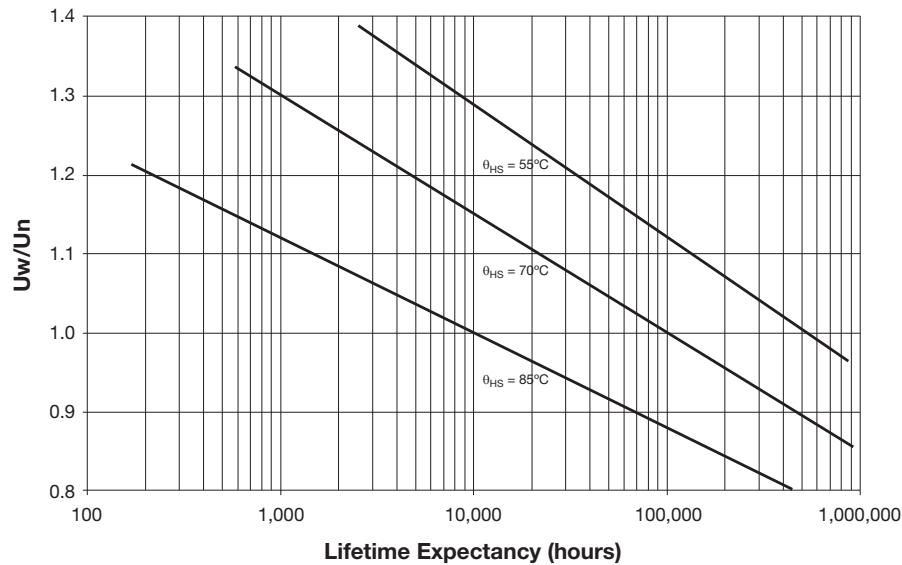

Expected lifetime at hot spot calculated and U = U_w

Архангельск (8182)63-90-72
Астана (7172)727-132
Астрахань (8512)99-46-04
Барнаул (3852)73-04-60
Белгород (4722)40-23-64
Брянск (4832)59-03-52
Владивосток (423)249-28-31
Волгоград (844)278-03-48
Вологда (8172)26-41-59
Воронеж (473)204-51-73
Екатеринбург (343)384-55-89
Иваново (4932)77-34-06

Ижевск (3412)26-03-58
Иркутск (395)279-98-46
Казань (843)206-01-48
Калининград (4012)72-03-81
Калуга (4842)92-23-67
Кемерово (3842)65-04-62
Киров (8332)68-02-04
Краснодар (861)203-40-90
Красноярск (391)204-63-61
Курск (4712)77-13-04
Липецк (4742)52-20-81
Киргизия (996)312-96-26-47

Магнитогорск (3519)55-03-13
Москва (495)268-04-70
Мурманск (8152)59-64-93
Набережные Челны (8552)20-53-41
Нижний Новгород (831)429-08-12
Новокузнецк (3843)20-46-81
Новосибирск (383)227-86-73
Омск (3812)21-46-40
Орел (4862)44-53-42
Оренбург (3532)37-68-04
Пенза (8412)22-31-16
Россия (495)268-04-70

Пермь (342)205-81-47
Ростов-на-Дону (863)308-18-15
Рязань (4912)46-61-64
Самара (846)206-03-16
Санкт-Петербург (812)309-46-40
Саратов (845)249-38-78
Севастополь (8692)22-31-93
Симферополь (3652)67-13-56
Смоленск (4812)29-41-54
Сочи (862)225-72-31
Ставрополь (8652)20-65-13
Казахстан (772)734-952-31

Сургут (3462)77-98-35
Тверь (4822)63-31-35
Томск (3822)98-41-53
Тула (4872)74-02-29
Тюмень (3452)66-21-18
Ульяновск (8422)24-23-59
Уфа (347)229-48-12
Хабаровск (4212)92-98-04
Челябинск (351)202-03-61
Череповец (8202)49-02-64
Ярославль (4852)69-52-93