

Архангельск (8182)63-90-72  
Астана (7172)727-132  
Астрахань (8512)99-46-04  
Барнаул (3852)73-04-60  
Белгород (4722)40-23-64  
Брянск (4832)59-03-52  
Владивосток (423)249-28-31  
Волгоград (844)278-03-48  
Вологда (8172)26-41-59  
Воронеж (473)204-51-73  
Екатеринбург (343)384-55-89  
Иваново (4932)77-34-06

Ижевск (3412)26-03-58  
Иркутск (395)279-98-46  
Казань (843)206-01-48  
Калининград (4012)72-03-81  
Калуга (4842)92-23-67  
Кемерово (3842)65-04-62  
Киров (8332)68-02-04  
Краснодар (861)203-40-90  
Красноярск (391)204-63-61  
Курск (4712)77-13-04  
Липецк (4742)52-20-81  
Киргизия (996)312-96-26-47

Магнитогорск (3519)55-03-13  
Москва (495)268-04-70  
Мурманск (8152)59-64-93  
Набережные Челны (8552)20-53-41  
Нижний Новгород (831)429-08-12  
Новокузнецк (3843)20-46-81  
Новосибирск (383)227-86-73  
Омск (3812)21-46-40  
Орел (4862)44-53-42  
Оренбург (3532)37-68-04  
Пенза (8412)22-31-16  
Россия (495)268-04-70

Пермь (342)205-81-47  
Ростов-на-Дону (863)308-18-15  
Рязань (4912)46-61-64  
Самара (846)206-03-16  
Санкт-Петербург (812)309-46-40  
Саратов (845)249-38-78  
Севастополь (8692)22-31-93  
Симферополь (3652)67-13-56  
Смоленск (4812)29-41-54  
Сочи (862)225-72-31  
Ставрополь (8652)20-65-13  
Казахстан (772)734-952-31

Сургут (3462)77-98-35  
Тверь (4822)63-31-35  
Томск (3822)98-41-53  
Тула (4872)74-02-29  
Тюмень (3452)66-21-18  
Ульяновск (8422)24-23-59  
Уфа (347)229-48-12  
Хабаровск (4212)92-98-04  
Челябинск (351)202-03-61  
Череповец (8202)49-02-64  
Ярославль (4852)69-52-93

<https://avx.nt-rt.ru/> || [axv@nt-rt](mailto:axv@nt-rt)



# High Power Capacitors

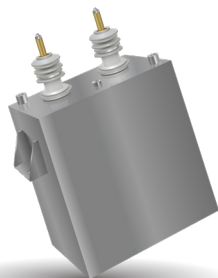
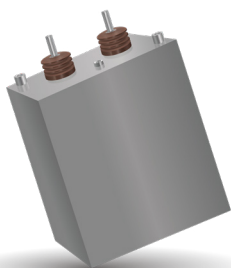

---

## **IMPORTANT INFORMATION/DISCLAIMER**

All product specifications, statements, information and data (collectively, the “Information”) in this datasheet or made available on the website are subject to change. The customer is responsible for checking and verifying the extent to which the Information contained in this publication is applicable to an order at the time the order is placed. All Information given herein is believed to be accurate and reliable, but it is presented without guarantee, warranty, or responsibility of any kind, expressed or implied.

Statements of suitability for certain applications are based on KYOCERA AVX’s knowledge of typical operating conditions for such applications, but are not intended to constitute and KYOCERA AVX specifically disclaims any warranty concerning suitability for a specific customer application or use.

**ANY USE OF PRODUCT OUTSIDE OF SPECIFICATIONS OR ANY STORAGE OR INSTALLATION INCONSISTENT WITH PRODUCT GUIDANCE VOIDS ANY WARRANTY.**

The Information is intended for use only by customers who have the requisite experience and capability to determine the correct products for their application. Any technical advice inferred from this Information or otherwise provided by KYOCERA AVX with reference to the use of KYOCERA AVX’s products is given without regard, and KYOCERA AVX assumes no obligation or liability for the advice given or results obtained.

Although KYOCERA AVX designs and manufactures its products to the most stringent quality and safety standards, given the current state of the art, isolated component failures may still occur. Accordingly, customer applications which require a high degree of reliability or safety should employ suitable designs or other safeguards (such as installation of protective circuitry or redundancies) in order to ensure that the failure of an electrical component does not result in a risk of personal injury or property damage.

Unless specifically agreed to in writing, KYOCERA AVX has not tested or certified its products, services or deliverables for use in high risk applications including medical life support, medical device, direct physical patient contact, water treatment, nuclear facilities, weapon systems, mass and air transportation control, flammable environments, or any other potentially life critical uses. Customer understands and agrees that KYOCERA AVX makes no assurances that the products, services or deliverables are suitable for any high-risk uses. Under no circumstances does KYOCERA AVX warrant or guarantee suitability for any customer design or manufacturing process.

Although all product–related warnings, cautions and notes must be observed, the customer should not assume that all safety measures are indicated or that other measures may not be required.

# HIGH POWER CAPACITORS

## Table of Contents

### FIM PRODUCTS

General Description .....	1
FIM Ranges Overview .....	2
Tangent of Loss Angle VS Frequency .....	3
Tangent of Loss Angle VS Temperature	
$\Delta C/C$ VS Hot Spot Temperature .....	4
Dimensions	
Handling	
Assembly and Installation.....	5
Marking	
Safety.....	6
Oil	
Non-Toxic Composition	
Capacitors Disposal	

### TRAFIM PRODUCTS

1950Vdc to 6000Vdc .....	7
Packaging Material	
Standards	
How To Order	
Definitions .....	8
Characteristics	
Lifetime Expectancy VS Hot SPot Temperature and Voltage	
How to Chose the Right Capacitor.....	9
Thermal Resistances .....	11
Parasitic Inductance VS Size	
MTBF Calculation .....	12
General Failure Rate	
Mean Time Between Failure (MTBF)	
Survival Function	
Failure Mode	
Dimensions .....	13
Weight VS Size .....	15
Ratings and Part Number Reference .....	16
Calculation Form .....	28
Lifetime Expectancy VS Hot Spot Temperature and Voltage	

### FILFIM PRODUCTS

6500Vdc to 56000Vdc .....	30
Packaging Material	
Standards	
How to Order	
General Description	
Definitions .....	31
Characteristics	
Lifetime Expectancy VS Hot Spot Temperature and Voltage	
How to Chose the Right Capacitor.....	32
Thermal Resistances .....	33
Parasitic Inductance VS Size	
Weight VS Size	
MTBF Calculation .....	34
General Failure Rate	
Mean Time Between Failure (MTBF)	
Survival Function	
Failure Mode	

Dimensions .....	35
Terminals	
Ratings and Part Number Reference .....	36
Calculation Form .....	37
Lifetime Expectancy VS Hot Spot Temperature and Voltage	

# FIM PRODUCTS

## General Description

### FIM RANGES OVERVIEW

#### TRAFIM



110 $\mu$ F to 10600 $\mu$ F  
1950V to 6000V  
Up to 495J/l for 100khours lifetime at 70°C hot spot temp  
Maximum hot spot temperature 95°C  
High RMS current capability  
Low inductance design  
Stainless steel hermetic case

DC link or resonant filtering for traction and industrial applications

Available on customized design as well

#### FILFIM



2.6 $\mu$ F to 612 $\mu$ F  
6500V to 56000V  
Up to 250J/l for 100khours lifetime at 70°C  
Stainless steel hermetic case

High voltage DC filtering for industrial and research applications

Available on customized design as well

#### DISFIM



Only available on customized design

Up to 40mF  
Up to 100kV  
Up to 2000J/l for short lifetime (shots)  
Stainless steel hermetic case

Discharge applications for industrial and research applications

Integration in frames or cabinets available

# FIM PRODUCTS

## General Description

### TANGENT OF LOSS ANGLE VS FREQUENCY

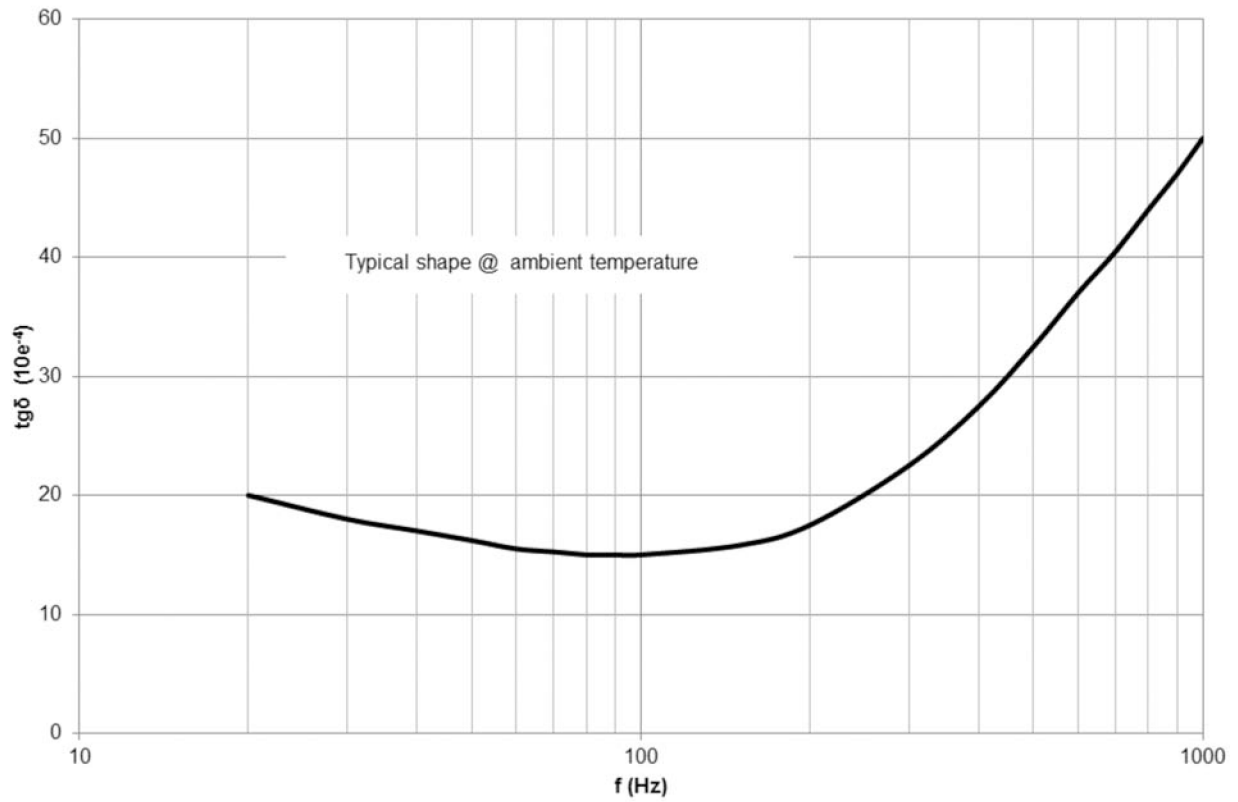

### TANGENT OF LOSS ANGLE VS TEMPERATURE

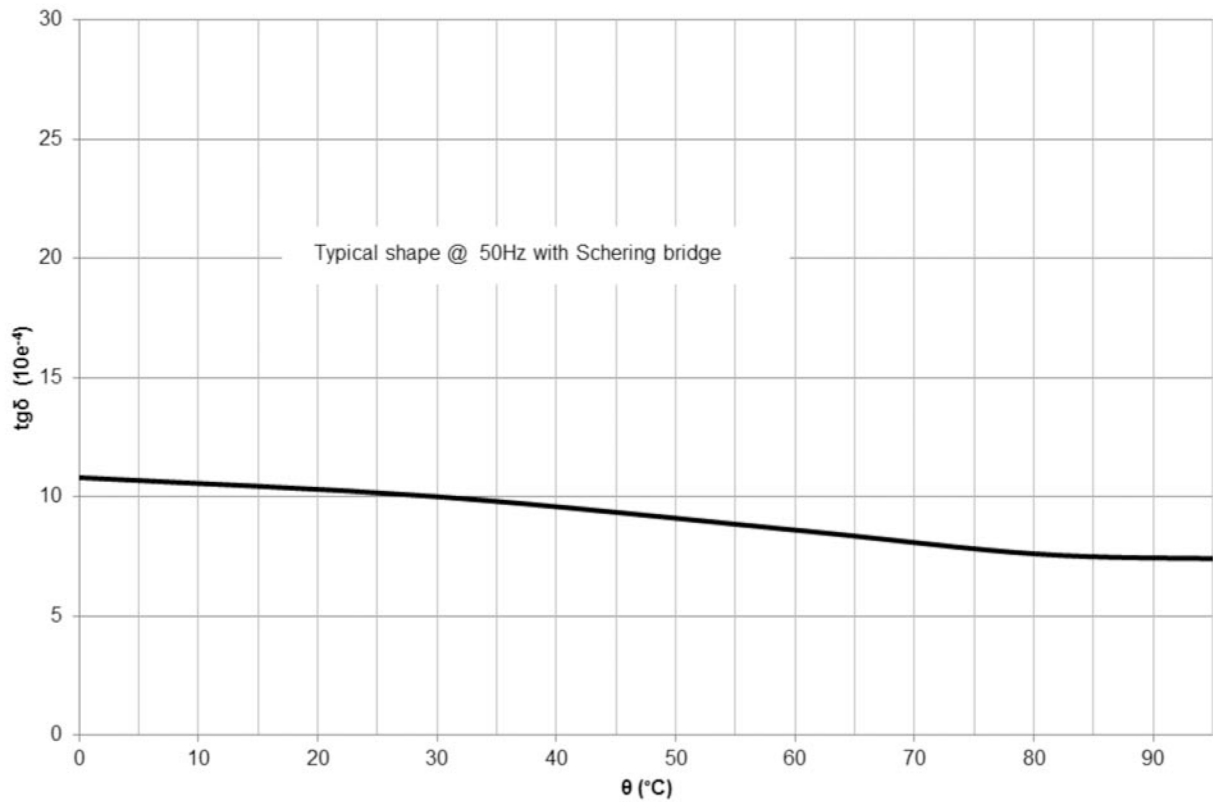

# FIM PRODUCTS

## General Description

### ΔC/C VS HOT SPOT TEMPERATURE

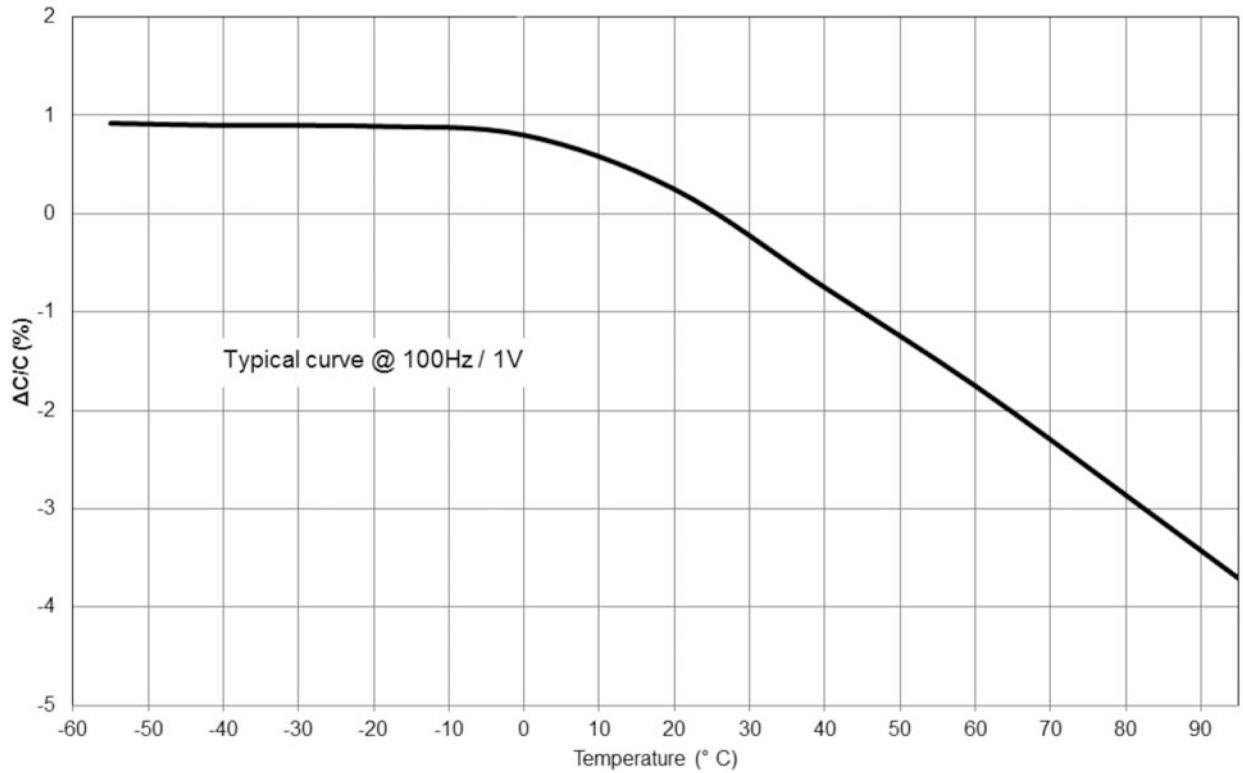

### DIMENSIONS

Dimensions and weights are indicated in the tables of values. Dimensional tolerances are:

$$H \pm 3\text{mm}, W \pm 3\text{mm}$$

Initially, the large faces of the capacitor may be slightly convex.

At delivery, the maximum width

$$(W_{\text{max}}) \text{ is } W + 15\text{mm}$$

Standard material is stainless steel. Aluminium is available for specific requirement to reduce the weight or induction effect.

### HANDLING

When unpacking, make sure that no mechanical shocks, that might deform the cans or damage the terminals, occur.

The capacitors have to be handled by using the nuts HmM10 (eyebolt) or the brackets.

**In no case, the electrical output terminals must be used to lift the capacitor.**

**The grounding wire should be kept in place until the mounting of the capacitor.**

# FIM PRODUCTS

## General Description

### ASSEMBLY AND INSTALLATION



#### Check the absence of excessive mechanical stresses

The mechanical stresses in assembly should remain compatible with the characteristics of the capacitor. The method of mounting should not lead to the deformation of the capacitor case.

Comply with the maximum tightening torques stipulated for the terminals.

#### Mechanical mounting

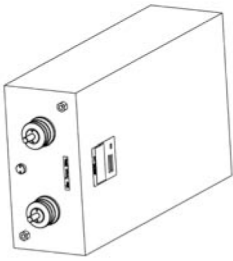
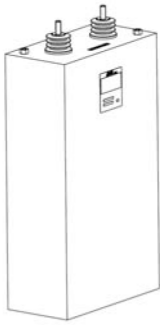
Vertical mounting is preferred and horizontal is acceptable. Please contact KYOCERA AVX for upside down mounting configuration.

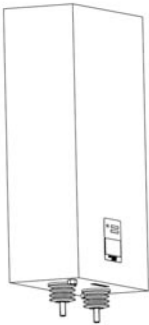
			
<b>Preferred</b>	<b>Preferred</b>	<b>Acceptable</b>	<b>On specific request</b>

In order to enable air convection, it is necessary to maintain at least 40mm between the large faces of the capacitor.

#### Connections

They should not induce any constraint on the output terminals. Flexible connections should be used (braided in thin metal). The cross section should not be less than:  $S=0.2 \times I_{max} \quad S(\text{mm}^2)$  and  $I_{max} \text{ (A)}$

The skin effect, which occurs vs frequency, must also be considered.

### MARKING

The label is usually located 50mm from the top of the case and centred to the length.

#### Informations:

KYOCERA AVX/TPC logo  
Part Number  
Capacitance and tolerance  
Nominal voltage

Test voltage between terminals and case  
Batch and serial number  
Date of manufacturing

# FIM PRODUCTS

---

## General Description

### SAFETY

The **FIM** technology provides excellent safety. There is no risk of explosion in case of defect throughout the life of the capacitor. This explains why there is no need to equip these capacitors with pressure switch.

Rapeseed oil is not explosive or flammable at normal conditions, therefore capacitors can be transported without being subjected to safety rules. Rapeseed oil flash point is about 317°C and the polypropylene flash point is 350°C leading to a temperature of security above 317°C.

In case of fire above this temperature, it is recommended to use powder or CO<sub>2</sub>. The use of water is contra-indicated. The possible rejected products during fire are mainly hydrocarbons in case of non-complete combustion, H<sub>2</sub>O, CO<sub>2</sub> and CO otherwise. Carrying mask is required for protection.

### OIL

The only impregnant used in **FIM** capacitors is rapeseed oil (otherwise known as Canola oil) and then it is fully environmentally compatible.

Of all the vegetable oils, rapeseed oil has one of the best thermal stability.

### NON-TOXIC COMPOSITION

Our capacitors are free of:

Arsenic, Asbestos, Beryllium, Brominated flame retardants (PBB and PBDE), Cadmium, CFC, HCFC, Cobalt, Formaldehyde, Halon, Isocyanatos, Mercury, Nickel, PCB, PCT, Polyaromatic, Hydrocarbons (PAH), Phtalates, PVC, PTFE and Thirams.

Lead is only found in soldering (for approximatively 0.3% of the capacitor weight).

Free of SF<sub>6</sub>.

### CAPACITORS DISPOSAL

The disposal of the capacitors is subjected to the laws in force in each country.

In practice, today, please contact KYOCERA AVX for a list of companies who can take charge of the products to be destroyed.



# TRAFIM PRODUCTS

1950Vdc to 6000Vdc



## GENERAL DESCRIPTION

The TRAFIM series is specifically designed for DC filtering applications such as DC link or resonant filters for voltages up to 6000V.

Large case sizes up to 46 liters and high specific energy up to 495J/l\* together with safe and reliable **Controlled Self Healing Technology** make this series particularly suitable for power converters in traction, drives, renewable energy and power transmission areas.  
\*for 100,000 hours and 70°C hot spot temperature

The **Controlled Self Healing Technology** is based on a high temperature grade metallized film impregnated with vegetable oil allowing operating temperature up to 95°C.

Standard designs proposed in this catalogue are covering a wide range of voltage and capacitance values.

In case of specific requirements about shape and performances, feel free to contact your local KYOCERA AVX representative.

## PACKAGING MATERIAL

Not painted rectangular nonmagnetic stainless steel hermetic case

With or without mounting brackets

Grounding through a nut on the top of the case

M8/17 female terminals or M12/30 male terminals

2 or 4 waves terminals

2 or 4 terminals

## STANDARDS

**IEC 61071:** Power electronic capacitors

**IEC 61881:** Railway applications, rolling stock equipment, capacitors for power electronics

**IEC 61373:** Railways application, rolling stock equipment, shock and vibration tests

**IEC 60068-2:** Environmental testing. Part 2: Tests

**EN 45545:** Railways applications – Fire protection on railway vehicles

Part 2: Requirements for fire behaviour of materials and components

Part 5: Fire safety requirements for electrical equipment including that of trolley buses, track guided buses and magnetic levitation vehicles

## HOW TO ORDER

<b>DK</b>	<b>TFM</b>	<b>1</b>	<b>1</b>	<b>M</b>	<b>B</b>	<b>1347</b>
<b>Series</b>	<b>Section and Option</b>	<b>Terminals Type</b>	<b>Fixing</b>	<b>Voltage</b>	<b>Capacitance EIA code</b>	
	1 = 340x117 2 Terminals	1, 2, 3 or 4	W = without	B = 1950V H = 3750V		
	2 = 340x117 4 Terminals	See drawings	M = brackets	C = 2150V I = 4200V		
	3 = 340x165 2 Terminals			D = 2350V J = 4700V		
	4 = 340x165 4 Terminals			E = 2600V K = 5200V		
				F = 2900V L = 5800V		
				G = 3150V M = 6000V		

# TRAFIM PRODUCTS

1950Vdc to 6000Vdc

## DEFINITIONS

$C_n$ ( $\mu\text{F}$ )	capacitance	nominal value of the capacitance measured at $\theta_{\text{amb}} = 25^\circ\text{C} \pm 10^\circ\text{C}$
$U_n$ (V)	rated DC voltage	maximum operating peak voltage of either polarity (non-reversing type waveform), for which the capacitor has been designed for continuous operation
$U_w$ (V)	working voltage	value of the maximum operating recurrent voltage for a given hot spot temperature and an expected lifetime
$U_r$ (V)	ripple voltage	peak-to-peak alternating component of the unidirectional voltage
$L_s$ (nH)	parasitic inductance	capacitor series self-inductance
$R_s$ (m $\Omega$ )	series resistance	capacitor series resistance due to galvanic circuit @ amb temperature
$I_{\text{rms Thermal 1}}$ (A)	RMS current	rms current value @ 100Hz for continuous operation under natural convection generating $20^\circ\text{C}$ overheating ( $255A_{\text{rms}}$ maximum for 2 connexions or terminals and $400A_{\text{rms}}$ maximum for 4 connexions or terminals)
$I_{\text{rms Thermal 2}}$ (A)	RMS current	rms current value @ 100Hz for continuous operation under forced air generating $20^\circ\text{C}$ overheating ( $255A_{\text{rms}}$ maximum for 2 terminals and $400A_{\text{rms}}$ maximum for 4 terminals)
$\theta_{\text{amb}}$ ( $^\circ\text{C}$ )	cooling air temperature	temperature of the cooling air measured at the hottest position of the capacitor, under steady-state conditions, midway between two units NOTE If only one unit is involved, it is the temperature measured at a point approximately 0.1 m away from the capacitor container and at two-thirds of the height from its base
$\theta_{\text{HS}}$ ( $^\circ\text{C}$ )	hot spot temperature	highest temperature obtained inside the case of the capacitor in thermal equilibrium

## CHARACTERISTICS

Capacitance range $C_n$	110 $\mu\text{F}$ to 10600 $\mu\text{F}$
Tolerance on $C_n$	$\pm 10\%$
Rated DC voltage $U_n$	1950 to 6000V
Lifetime at $U_n$ and $80^\circ\text{C}$ hot-spot temperature and $\Delta C / C < 2\%$	100,000h
Parasitic inductance $L_s$	24nH to 149nH
Maximum rms current $I_{\text{rms}}$	up to $400A_{\text{rms}}$
Test voltage between terminals @ $25^\circ\text{C}$	$1.5 \times U_n$ for 10s
Test voltage between terminals and Case @ $25^\circ\text{C}$	$(2 \times U_n + 1000)V_{\text{rms}}$ @ 50Hz for 10s
Dielectric Film	Polypropylene
Dielectric Liquid Filling	Rape seed oil
Climatic Category	55 / 95 / 56 (IEC 60068)
Working temperature	$-55^\circ\text{C} / +95^\circ\text{C}$ (according to the power dissipated)
Storage temperature	$-55^\circ\text{C} / +95^\circ\text{C}$
Calorific value	30 MJ/kg

# TRAFIM PRODUCTS

1950Vdc to 6000Vdc

## LIFETIME EXPECTANCY VS HOT SPOT TEMPERATURE AND VOLTAGE

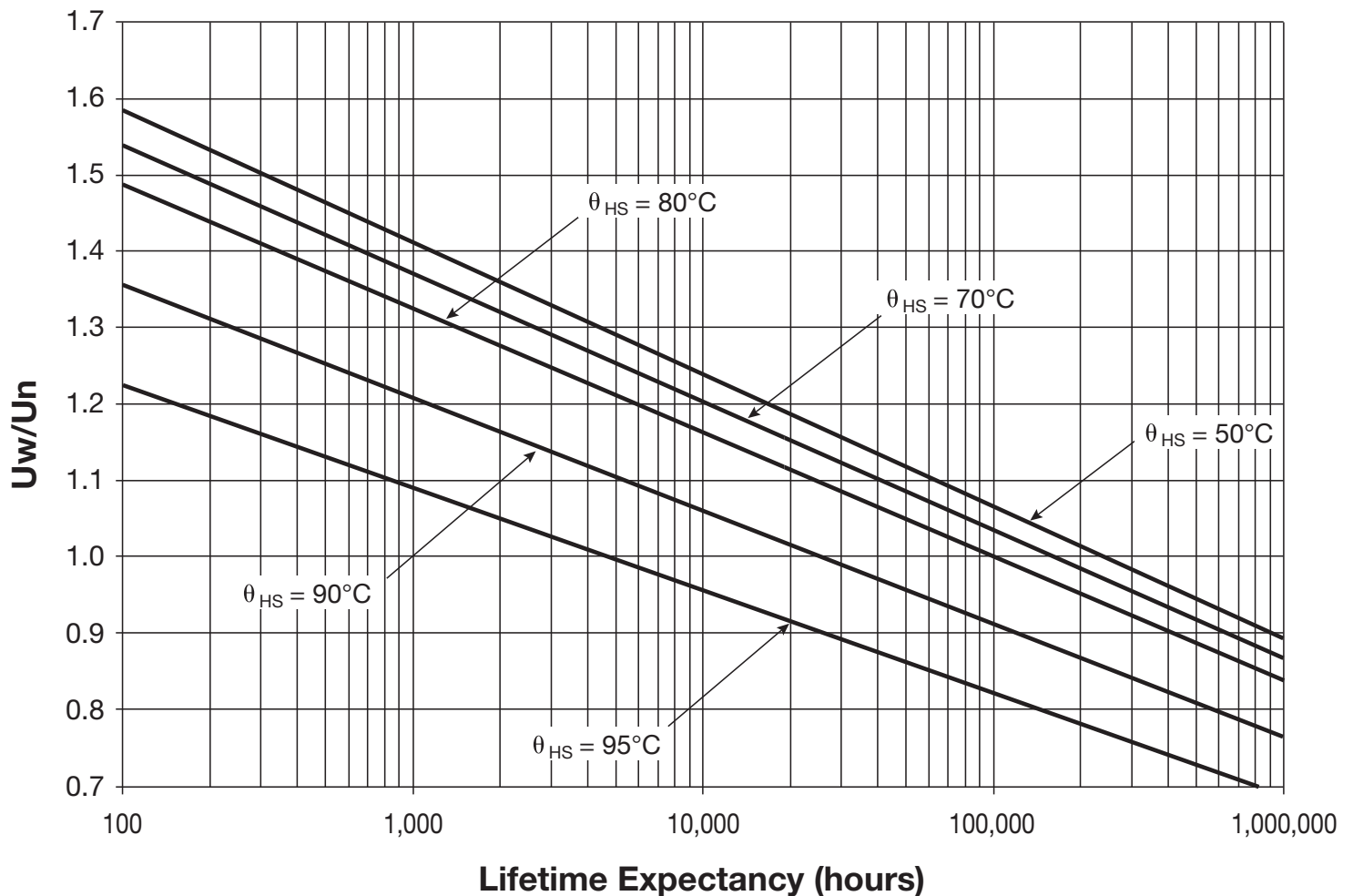

## HOW TO CHOSE THE RIGHT CAPACITOR

The capacitor lifetime depends on the working voltage and the hot spot temperature.

Our caps are designed to meet 100,000 hours lifetime at rated voltage and  $80^\circ\text{C}$  hot spot temperature. In accordance with operating conditions, please calculate the hot spot temperature and deduce from this calculation if the obtained lifetime can suit the application.

### 1. From the tables, select a capacitor with required capacitance $C_n$ and voltage $U_n$ .

Calculate the maximum ripple voltage allowed for the selected cap:

$$U_{rmax} = 0.2U_n$$

If  $U_r > U_{rmax}$ , select a capacitor with higher rated voltage or contact your local sales representative

Make sure  $I_{rms}$  application  $<$   $I_{rms}$  table

Copy out:

- serial resistance ( $R_s$ ): see table of values
- thermal resistances  $R_{th1}$  and  $R_{th2}$  (depending on cooling conditions)

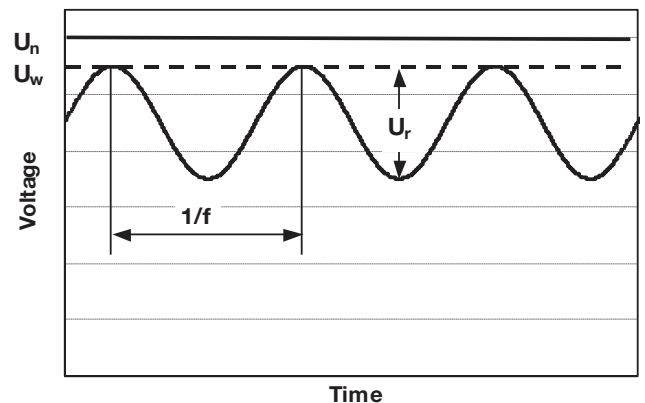

# TRAFIM PRODUCTS

## 1950Vdc to 6000Vdc

### 2. Hot spot temperature calculation

Total losses are calculated as follow:  $P_t = P_j + P_d$

Joule losses:  $P_j = R_s \times I_{rms}^2$

Dielectric losses:  $P_d = Q \times \text{tg}\delta_0$  with

- $Q$  (reactive power) =  $\frac{I_{rms}^2}{C}$  for a sinusoidal waveform

- $\text{tg}\delta_0 = 3 \times 10^{-4}$  (dielectric losses of polypropylene + oil)

Hot spot temperature will be:

$$\theta_{HS} = \theta_{amb} + (P_j + P_d) \times (R_{th1} + R_{th2})$$

$\theta_{HS}$  **absolute maximum is 95°C**

If temperature is higher than 95°C, come back to #1 and start again with another selection.

$R_{th1}$ : thermal resistance between hot spot and case

$R_{th2}$ : thermal resistance between case and ambient air

$R_{th1}$ : thermal resistance between hot spot and case

$R_{th2}$ : thermal resistance between case and ambient air

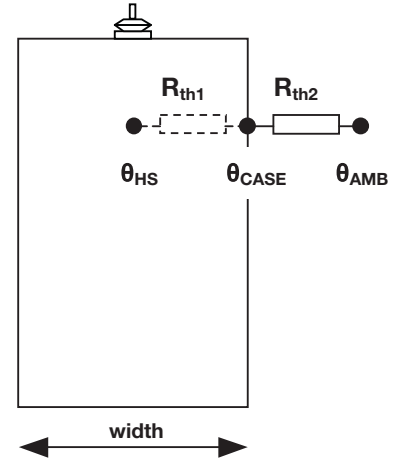

### 3. Refer to the curve and deduce the lifetime vs $U_w/U_n$ ratio

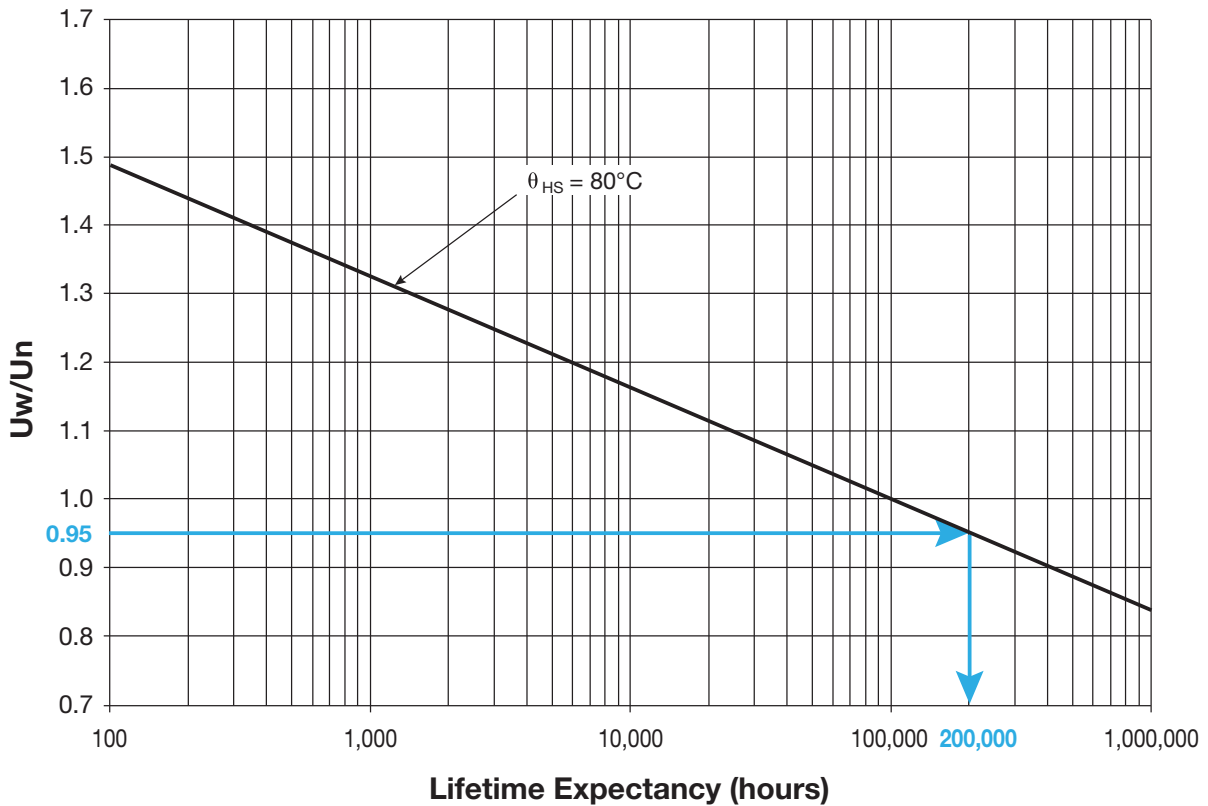

eg: rated voltage 2000V

working voltage 1900V

$\rho = 0.95 \Rightarrow$  lifetime 200,000 hours @ 80°C hot spot temperature

Find a calculation form at the end of the catalog

# TRAFIM PRODUCTS

1950Vdc to 6000Vdc

## THERMAL RESISTANCES

$R_{th1}$  (°C/W): Thermal resistance between hot spot and case

$R_{th2}$  (°C/W): Thermal resistance between case and ambient air under natural convection and forced air

Height (mm)	$R_{th1}$ (°C/W)		$R_{th2}$ (°C/W) Natural air cooling		$R_{th2}$ (°C/W) Forced air cooling >2m/s	
	Width (mm)		Width (mm)		Width (mm)	
	117	165	117	165	117	165
215	0.23	0.29	0.34	0.29	0.17	0.15
290	0.18	0.23	0.26	0.23	0.13	0.11
365	0.14	0.19	0.21	0.19	0.11	0.09
440	0.12	0.16	0.18	0.16	0.09	0.08
515	0.1	0.14	0.16	0.14	0.08	0.07
590	0.09	0.12	0.14	0.12	0.07	0.06
705	0.08	0.1	0.12	0.1	0.06	0.05
815	0.07	0.09	0.1	0.09	0.05	0.05



For confined area, capacitor working in a closed cabinet, a thermal test under real conditions is necessary to evaluate the thermal resistance.

## PARASITIC INDUCTANCE VS SIZE

Measurement @ 1MHz

Height (mm)	Ls (nH)							
	2 terminals type 1/2		2 terminals type 3/4		4 terminals type 1/2		4 terminals type 3/4	
	Width (mm)		Width (mm)		Width (mm)		Width (mm)	
	117	165	117	165	117	165	117	165
215	69	73	109	113	24	28	34	38
290	72	78	112	118	27	33	37	43
365	75	82	115	122	30	37	40	47
440	78	87	118	127	33	42	43	52
515	81	91	121	131	36	46	46	56
590	84	96	124	136	39	51	49	61
705	89	103	129	143	44	58	54	68
815	93	109	133	149	48	64	58	74

# TRAFIM PRODUCTS

## 1950Vdc to 6000Vdc

### MTBF CALCULATION

The failure rate  $\lambda_B$  depends on hot spot temperature  $\theta_{HS}$  and charge ratio  $\rho$ .

$$\rho = U_w/U_n$$

$$\lambda_B = 3 \times 10^{5,738(\rho-1)} \times e^{\left(3,933 \left(\frac{\theta_{HS}+273}{368}\right)^{27,75}\right)} \times 10^{-9} \text{ in failures/hour}$$

### GENERAL FAILURE RATE

$\lambda = \lambda_B \times \pi_Q \times \pi_B \times \pi_E$  failures/hour •  $\pi_Q$ ,  $\pi_B$  and  $\pi_E$  see following tables

Qualification	Qualification factor $\pi_Q$
Product qualified on IEC61071 or IEC61881 and internal qualification	1
Product qualified on IEC61071 or IEC61881	2
Product answering on another norm	5
Product without qualification	15

Environment	Environment factor $\pi_E$
On ground (good conditions)	1
On ground (fixed materials)	2
On ground (on board)	4
On ship	9
On plane	15

Environment	Environment factor $\pi_B$
Favorable	1
Unfavourable	5

### MEAN TIME BETWEEN FAILURE (MTBF)

$$MTBF = 1/\lambda \text{ hours}$$

### SURVIVAL FUNCTION

$$N = N_0 \times \exp(-\lambda t)$$

N is the number of pieces still working after t hours.

$N_0$  is the number of pieces at the origin (t = 0)

### FAILURE MODE

Main failure mode due to KYOCERA AVX's **Controlled Self-Healing Technology** is only losses of capacitance. Thanks to the **Controlled Self-Healing Technology**, the efficient solution to interrupt the self-healing process and prevent the avalanche effect leading to the worse sequence of events for none controlled self-healing capacitors: polypropylene molecular cracking, gas emission and potential explosion in confined box.

# TRAFIM PRODUCTS

1950Vdc to 6000Vdc

## DIMENSIONS

Lower brackets removed for H<500mm

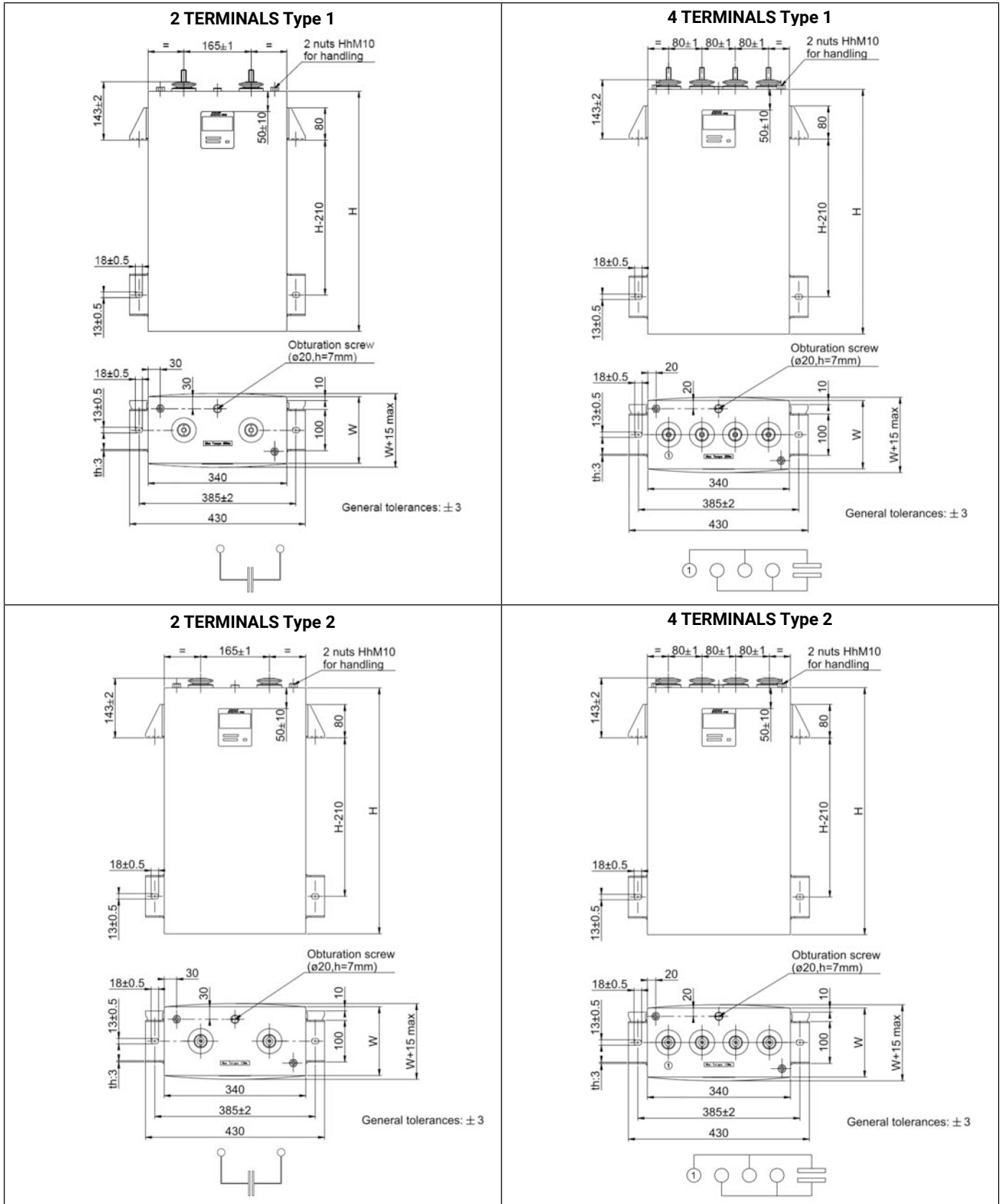





# TRAFIM PRODUCTS

1950Vdc to 6000Vdc

## DIMENSIONS

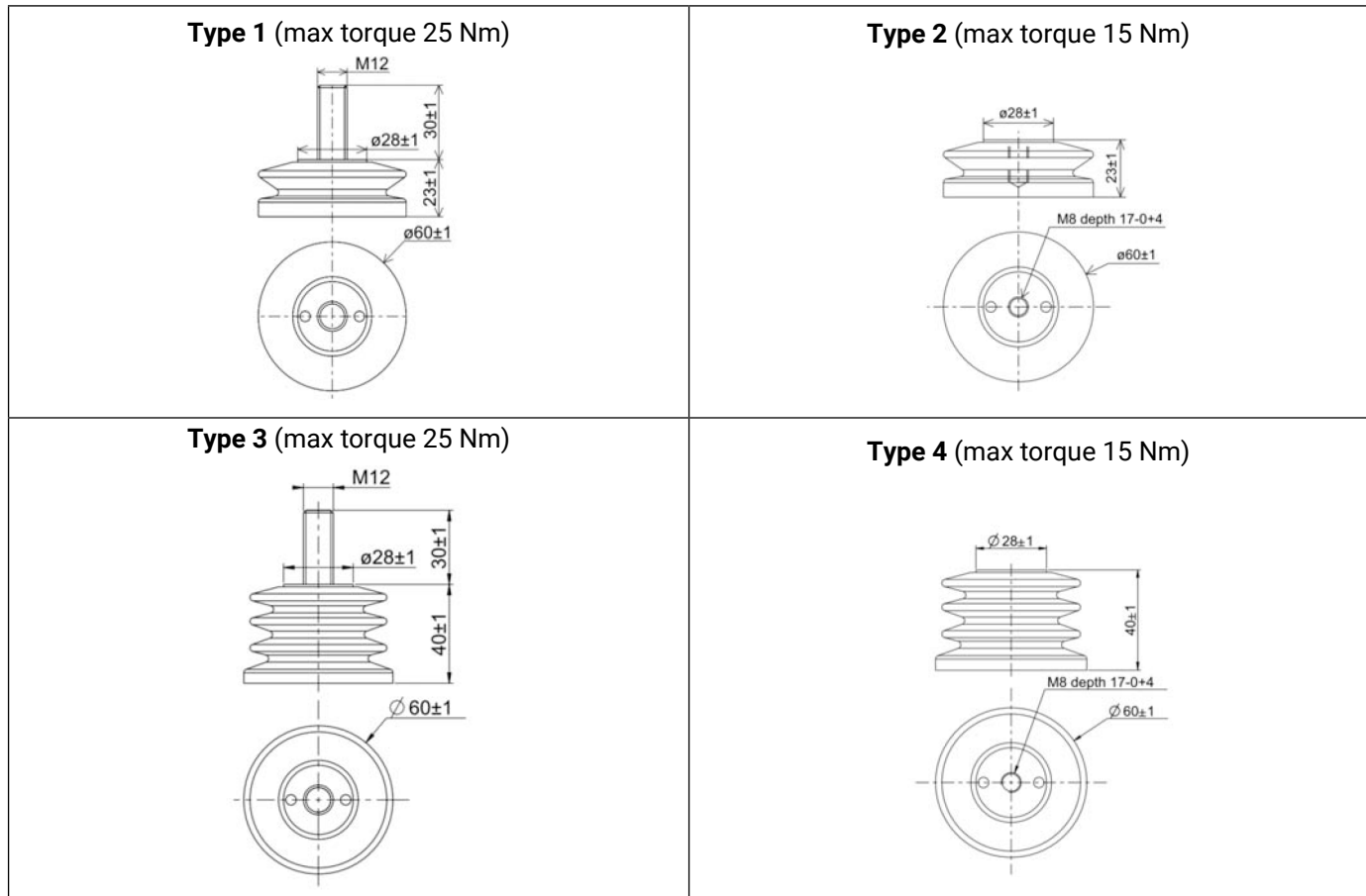

Terminals type	Creepage distance	Air distance
1 and 2	52mm	30mm
3 and 4	84mm	50mm

## WEIGHT VS SIZE

Height (mm)	Weight (kg)			
	2 terminals		4 terminals	
	Width (mm)		Width (mm)	
215	<b>117</b>	<b>165</b>	<b>117</b>	<b>165</b>
290	14	19	15	20
365	18	24	19	25
440	21.5	29	22.5	30
515	25.5	34.5	26.5	35.5
590	30	39.5	31	40.5
705	34	44.5	35	45.5
815	40	52.5	41	53.5
	45.5	60	46.5	61

# TRAFIM PRODUCTS

1950Vdc to 6000Vdc

## RATINGS AND PART NUMBER REFERENCE

Un = 1950Vdc						
Part Number	Capacitance (μF)	Width (mm)	Height (mm)	R <sub>s</sub> (mΩ)	I <sub>rms</sub> thermal 1 (A)	I <sub>rms</sub> thermal 2 (A)
DKTFM1*#B1347	1340	117	215	0.66	185	220
DKTFM2*#B1347	1340	117	215	0.58	195	230
DKTFM1*#B2027	2020	117	290	0.50	245	255
DKTFM2*#B2027	2020	117	290	0.42	260	310
DKTFM3*#B2117	2110	165	215	0.92	170	195
DKTFM4*#B2117	2110	165	215	0.83	180	205
DKTFM1*#B2707	2700	117	365	0.43	255	255
DKTFM2*#B2707	2700	117	365	0.35	320	385
DKTFM3*#B3177	3170	165	290	0.69	225	255
DKTFM4*#B3177	3170	165	290	0.60	240	275
DKTFM1*#B3367	3360	117	440	0.39	255	255
DKTFM2*#B3367	3360	117	440	0.31	380	400
DKTFM1*#B4037	4030	117	515	0.37	255	255
DKTFM2*#B4037	4030	117	515	0.29	400	400
DKTFM3*#B4237	4230	165	365	0.58	255	255
DKTFM4*#B4237	4230	165	365	0.49	295	340
DKTFM1*#B4707	4700	117	590	0.35	255	255
DKTFM2*#B4707	4700	117	590	0.27	400	400
DKTFM3*#B5297	5290	165	440	0.52	255	255
DKTFM4*#B5297	5290	165	440	0.43	345	400
DKTFM1*#B5727	5720	117	705	0.34	255	255
DKTFM2*#B5727	5720	117	705	0.26	400	400
DKTFM3*#B6347	6340	165	515	0.48	255	255
DKTFM4*#B6347	6340	165	515	0.39	390	400
DKTFM1*#B6737	6730	117	815	0.33	255	255
DKTFM2*#B6737	6730	117	815	0.25	400	400
DKTFM3*#B7407	7400	165	590	0.45	255	255
DKTFM4*#B7407	7400	165	590	0.36	400	400
DKTFM3*#B8987	8980	165	705	0.43	255	255
DKTFM4*#B8987	8980	165	705	0.34	400	400
DKTFM3*#B1068	10600	165	815	0.41	255	255
DKTFM4*#B1068	10600	165	815	0.32	400	400

\* Insert terminal type (1, 2, 3 or 4) # Insert W (without) or M (brackets) for fixing

# TRAFIM PRODUCTS

1950Vdc to 6000Vdc

## RATINGS AND PART NUMBER REFERENCE

Un = 2150Vdc						
Part Number	Capacitance (μF)	Width (mm)	Height (mm)	R <sub>s</sub> (mΩ)	I <sub>rms</sub> thermal 1 (A)	I <sub>rms</sub> thermal 2 (A)
DKTFM1*#C1067	1060	117	215	0.72	170	205
DKTFM2*#C1067	1060	117	215	0.64	180	215
DKTFM1*#C1607	1600	117	290	0.54	230	255
DKTFM2*#C1607	1600	117	290	0.46	240	290
DKTFM3*#C1687	1680	165	215	1.00	160	185
DKTFM4*#C1687	1680	165	215	0.91	165	195
DKTFM1*#C2147	2140	117	365	0.46	255	255
DKTFM2*#C2147	2140	117	365	0.38	300	360
DKTFM3*#C2527	2520	165	290	0.75	215	245
DKTFM4*#C2527	2520	165	290	0.66	225	260
DKTFM1*#C2677	2670	117	440	0.42	255	255
DKTFM2*#C2677	2670	117	440	0.34	350	400
DKTFM1*#C3207	3200	117	515	0.39	255	255
DKTFM2*#C3207	3200	117	515	0.31	400	400
DKTFM3*#C3367	3360	165	365	0.62	255	255
DKTFM4*#C3367	3360	165	365	0.53	280	320
DKTFM1*#C3737	3730	117	590	0.37	255	255
DKTFM2*#C3737	3730	117	590	0.29	400	400
DKTFM3*#C4207	4200	165	440	0.55	255	255
DKTFM4*#C4207	4200	165	440	0.46	325	380
DKTFM1*#C4557	4550	117	705	0.35	255	255
DKTFM2*#C4557	4550	117	705	0.27	400	400
DKTFM3*#C5047	5040	165	515	0.51	255	255
DKTFM4*#C5047	5040	165	515	0.42	375	400
DKTFM1*#C5357	5350	117	815	0.34	255	255
DKTFM2*#C5357	5350	117	815	0.26	400	400
DKTFM3*#C5887	5880	165	590	0.48	255	255
DKTFM4*#C5887	5880	165	590	0.39	400	400
DKTFM3*#C7147	7140	165	705	0.45	255	255
DKTFM4*#C7147	7140	165	705	0.36	400	400
DKTFM3*#C8407	8400	165	815	0.43	255	255
DKTFM4*#C8407	8400	165	815	0.34	400	400

\* Insert terminal type (1, 2, 3 or 4) # Insert W (without) or M (brackets) for fixing

# TRAFIM PRODUCTS

1950Vdc to 6000Vdc

## RATINGS AND PART NUMBER REFERENCE

Un = 2350Vdc						
Part Number	Capacitance (µF)	Width (mm)	Height (mm)	R <sub>s</sub> (mΩ)	I <sub>rms</sub> thermal 1 (A)	I <sub>rms</sub> thermal 2 (A)
DKTFM1*#D0917	910	117	215	0.76	165	195
DKTFM2*#D0917	910	117	215	0.68	170	205
DKTFM1*#D1367	1360	117	290	0.57	220	255
DKTFM2*#D1367	1360	117	290	0.49	230	275
DKTFM3*#D1427	1420	165	215	1.08	155	175
DKTFM4*#D1427	1420	165	215	0.99	160	185
DKTFM1*#D1827	1820	117	365	0.48	255	255
DKTFM2*#D1827	1820	117	365	0.40	285	345
DKTFM3*#D2147	2140	165	290	0.79	205	235
DKTFM4*#D2147	2140	165	290	0.70	215	250
DKTFM1*#D2277	2270	117	440	0.43	255	255
DKTFM2*#D2277	2270	117	440	0.35	340	400
DKTFM1*#D2727	2720	117	515	0.40	255	255
DKTFM2*#D2727	2720	117	515	0.32	390	400
DKTFM3*#D2857	2850	165	365	0.66	250	255
DKTFM4*#D2857	2850	165	365	0.57	265	310
DKTFM1*#D3177	3170	117	590	0.38	255	255
DKTFM2*#D3177	3170	117	590	0.30	400	400
DKTFM3*#D3577	3570	165	440	0.58	255	255
DKTFM4*#D3577	3570	165	440	0.49	315	360
DKTFM1*#D3857	3850	117	705	0.36	255	255
DKTFM2*#D3857	3850	117	705	0.28	400	400
DKTFM3*#D4287	4280	165	515	0.53	255	255
DKTFM4*#D4287	4280	165	515	0.44	360	400
DKTFM1*#D4537	4530	117	815	0.35	255	255
DKTFM2*#D4537	4530	117	815	0.27	400	400
DKTFM3*#D5007	5000	165	590	0.50	255	255
DKTFM4*#D5007	5000	165	590	0.41	400	400
DKTFM3*#D6077	6070	165	705	0.47	255	255
DKTFM4*#D6077	6070	165	705	0.37	400	400
DKTFM3*#D7147	7140	165	815	0.45	255	255
DKTFM4*#D7147	7140	165	815	0.35	400	400

\* Insert terminal type (1, 2, 3 or 4) # Insert W (without) or M (brackets) for fixing

# TRAFIM PRODUCTS

1950Vdc to 6000Vdc

## RATINGS AND PART NUMBER REFERENCE

Un = 2600Vdc						
Part Number	Capacitance (μF)	Width (mm)	Height (mm)	R <sub>s</sub> (mΩ)	I <sub>rms</sub> thermal 1 (A)	I <sub>rms</sub> thermal 2 (A)
DKTFM1*#E7356	735	117	215	0.82	150	185
DKTFM2*#E7356	735	117	215	0.74	155	190
DKTFM1*#E1107	1100	117	290	0.62	205	245
DKTFM2*#E1107	1100	117	290	0.54	215	255
DKTFM3*#E1157	1150	165	215	1.17	145	165
DKTFM4*#E1157	1150	165	215	1.08	150	170
DKTFM1*#E1477	1470	117	365	0.52	255	255
DKTFM2*#E1477	1470	117	365	0.44	270	320
DKTFM3*#E1737	1730	165	290	0.86	195	225
DKTFM4*#E1737	1730	165	290	0.77	200	235
DKTFM1*#E1847	1840	117	440	0.46	255	255
DKTFM2*#E1847	1840	117	440	0.38	320	380
DKTFM1*#E2207	2200	117	515	0.42	255	255
DKTFM2*#E2207	2200	117	515	0.34	365	400
DKTFM3*#E2307	2300	165	365	0.71	240	255
DKTFM4*#E2307	2300	165	365	0.62	250	290
DKTFM1*#E2577	2570	117	590	0.40	255	255
DKTFM2*#E2577	2570	117	590	0.32	400	400
DKTFM3*#E2877	2870	165	440	0.62	255	255
DKTFM4*#E2877	2870	165	440	0.53	300	345
DKTFM1*#E3127	3120	117	705	0.38	255	255
DKTFM2*#E3127	3120	117	705	0.30	400	400
DKTFM3*#E3457	3450	165	515	0.57	255	255
DKTFM4*#E3457	3450	165	515	0.47	340	395
DKTFM1*#E3687	3680	117	815	0.36	255	255
DKTFM2*#E3687	3680	117	815	0.28	400	400
DKTFM3*#E4027	4020	165	590	0.53	255	255
DKTFM4*#E4027	4020	165	590	0.44	380	400
DKTFM3*#E4907	4900	165	705	0.49	255	255
DKTFM4*#E4907	4900	165	705	0.40	400	400
DKTFM3*#E5737	5730	165	815	0.47	255	255
DKTFM4*#E5737	5730	165	815	0.38	400	400

\* Insert terminal type (1, 2, 3 or 4) # Insert W (without) or M (brackets) for fixing

# TRAFIM PRODUCTS

1950Vdc to 6000Vdc

## RATINGS AND PART NUMBER REFERENCE

Un = 2900Vdc						
Part Number	Capacitance (µF)	Width (mm)	Height (mm)	R <sub>s</sub> (mΩ)	I <sub>rms</sub> thermal 1 (A)	I <sub>rms</sub> thermal 2 (A)
DKTFM1*#F0617	610	117	215	0.89	140	170
DKTFM2*#F0617	610	117	215	0.81	145	175
DKTFM1*#F0917	910	117	290	0.66	195	235
DKTFM2*#F0917	910	117	290	0.58	200	240
DKTFM3*#F9556	955	165	215	1.27	135	160
DKTFM4*#F9556	955	165	215	1.17	140	165
DKTFM1*#F1217	1210	117	365	0.55	240	255
DKTFM2*#F1217	1210	117	365	0.47	250	300
DKTFM3*#F1437	1430	165	290	0.92	185	215
DKTFM4*#F1437	1430	165	290	0.83	190	220
DKTFM1*#F1527	1520	117	440	0.49	255	255
DKTFM2*#F1527	1520	117	440	0.41	300	360
DKTFM1*#F1827	1820	117	515	0.45	255	255
DKTFM2*#F1827	1820	117	515	0.37	345	400
DKTFM3*#F1917	1910	165	365	0.75	230	255
DKTFM4*#F1917	1910	165	365	0.66	240	275
DKTFM1*#F2127	2120	117	590	0.42	255	255
DKTFM2*#F2127	2120	117	590	0.34	390	400
DKTFM3*#F2387	2380	165	440	0.66	255	255
DKTFM4*#F2387	2380	165	440	0.57	285	330
DKTFM1*#F2587	2580	117	705	0.39	255	255
DKTFM2*#F2587	2580	117	705	0.31	400	400
DKTFM3*#F2867	2860	165	515	0.60	255	255
DKTFM4*#F2867	2860	165	515	0.50	325	375
DKTFM1*#F3047	3040	117	815	0.38	255	255
DKTFM2*#F3047	3040	117	815	0.30	400	400
DKTFM3*#F3347	3340	165	590	0.55	255	255
DKTFM4*#F3347	3340	165	590	0.46	365	400
DKTFM3*#F4067	4060	165	705	0.51	255	255
DKTFM4*#F4067	4060	165	705	0.42	400	400
DKTFM3*#F4777	4770	165	815	0.49	255	255
DKTFM4*#F4777	4770	165	815	0.39	400	400

\* Insert terminal type (1, 2, 3 or 4) # Insert **W** (without) or **M** (brackets) for fixing

# TRAFIM PRODUCTS

1950Vdc to 6000Vdc

## RATINGS AND PART NUMBER REFERENCE

Un = 3150Vdc						
Part Number	Capacitance (µF)	Width (mm)	Height (mm)	R <sub>s</sub> (mΩ)	I <sub>rms</sub> thermal 1 (A)	I <sub>rms</sub> thermal 2 (A)
DKTFM1*#G0517	510	117	215	0.95	135	160
DKTFM2*#G0517	510	117	215	0.87	140	165
DKTFM1*#G7656	765	117	290	0.70	185	220
DKTFM2*#G7656	765	117	290	0.62	190	225
DKTFM3*#G0807	800	165	215	1.36	130	150
DKTFM4*#G0807	800	165	215	1.27	135	155
DKTFM1*#G1027	1020	117	365	0.58	225	255
DKTFM2*#G1027	1020	117	365	0.50	235	280
DKTFM3*#G1207	1200	165	290	0.99	175	200
DKTFM4*#G1207	1200	165	290	0.90	180	210
DKTFM1*#G1277	1270	117	440	0.51	255	255
DKTFM2*#G1277	1270	117	440	0.43	280	335
DKTFM1*#G1537	1530	117	515	0.47	255	255
DKTFM2*#G1537	1530	117	515	0.39	320	385
DKTFM3*#G1607	1600	165	365	0.80	215	250
DKTFM4*#G1607	1600	165	365	0.71	225	260
DKTFM1*#G1787	1780	117	590	0.44	255	255
DKTFM2*#G1787	1780	117	590	0.36	365	400
DKTFM3*#G2007	2000	165	440	0.70	255	255
DKTFM4*#G2007	2000	165	440	0.61	270	310
DKTFM1*#G2177	2170	117	705	0.41	255	255
DKTFM2*#G2177	2170	117	705	0.33	400	400
DKTFM3*#G2407	2400	165	515	0.63	255	255
DKTFM4*#G2407	2400	165	515	0.54	310	360
DKTFM1*#G2557	2550	117	815	0.39	255	255
DKTFM2*#G2557	2550	117	815	0.31	400	400
DKTFM3*#G2807	2800	165	590	0.58	255	255
DKTFM4*#G2807	2800	165	590	0.49	350	400
DKTFM3*#G3407	3400	165	705	0.54	255	255
DKTFM4*#G3407	3400	165	705	0.44	400	400
DKTFM3*#G4007	4000	165	815	0.51	255	255
DKTFM4*#G4007	4000	165	815	0.41	400	400

\* Insert terminal type (1, 2, 3 or 4) # Insert **W** (without) or **M** (brackets) for fixing

# TRAFIM PRODUCTS

1950Vdc to 6000Vdc

## RATINGS AND PART NUMBER REFERENCE

Un = 3750Vdc						
Part Number	Capacitance (μF)	Width (mm)	Height (mm)	R <sub>s</sub> (mΩ)	I <sub>rms</sub> thermal 1 (A)	I <sub>rms</sub> thermal 2 (A)
DKTFM1*#H0337	330	117	215	1.14	110	130
DKTFM2*#H0337	330	117	215	1.06	115	135
DKTFM1*#H4956	495	117	290	0.83	155	185
DKTFM2*#H4956	495	117	290	0.75	160	190
DKTFM3*#H0537	530	165	215	1.63	115	130
DKTFM4*#H0537	530	165	215	1.54	120	135
DKTFM1*#H0667	660	117	365	0.67	195	230
DKTFM2*#H0667	660	117	365	0.59	200	240
DKTFM3*#H7956	795	165	290	1.16	155	180
DKTFM4*#H7956	795	165	290	1.07	160	185
DKTFM1*#H8256	825	117	440	0.59	230	255
DKTFM2*#H8256	825	117	440	0.51	240	290
DKTFM1*#H9856	985	117	515	0.53	255	255
DKTFM2*#H9856	985	117	515	0.45	280	335
DKTFM3*#H1067	1060	165	365	0.94	195	225
DKTFM4*#H1067	1060	165	365	0.84	200	230
DKTFM1*#H1157	1150	117	590	0.49	255	255
DKTFM2*#H1157	1150	117	590	0.41	315	380
DKTFM3*#H1327	1320	165	440	0.80	230	255
DKTFM4*#H1327	1320	165	440	0.71	240	275
DKTFM1*#H1407	1400	117	705	0.45	255	255
DKTFM2*#H1407	1400	117	705	0.37	370	400
DKTFM3*#H1597	1590	165	515	0.72	255	255
DKTFM4*#H1597	1590	165	515	0.63	275	320
DKTFM1*#H1657	1650	117	815	0.43	255	255
DKTFM2*#H1657	1650	117	815	0.35	400	400
DKTFM3*#H1857	1850	165	590	0.66	255	255
DKTFM4*#H1857	1850	165	590	0.57	310	360
DKTFM3*#H2257	2250	165	705	0.60	255	255
DKTFM4*#H2257	2250	165	705	0.51	360	400
DKTFM3*#H2657	2650	165	815	0.56	255	255
DKTFM4*#H2657	2650	165	815	0.47	400	400

\* Insert terminal type (1, 2, 3 or 4) # Insert **W** (without) or **M** (brackets) for fixing



# TRAFIM PRODUCTS

1950Vdc to 6000Vdc

## RATINGS AND PART NUMBER REFERENCE

Un = 4200Vdc						
Part Number	Capacitance (µF)	Width (mm)	Height (mm)	R <sub>s</sub> (mΩ)	I <sub>rms</sub> thermal 1 (A)	I <sub>rms</sub> thermal 2 (A)
DKTFM1*#I0267	260	117	215	1.26	100	120
DKTFM2*#I0267	260	117	215	1.18	105	125
DKTFM1*#I0397	390	117	290	0.91	140	170
DKTFM2*#I0397	390	117	290	0.83	145	175
DKTFM3*#I0427	420	165	215	1.80	105	120
DKTFM4*#I0427	420	165	215	1.71	110	125
DKTFM1*#I0527	520	117	365	0.73	180	215
DKTFM2*#I0527	520	117	365	0.65	185	220
DKTFM3*#I0637	630	165	290	1.28	140	165
DKTFM4*#I0637	630	165	290	1.19	145	170
DKTFM1*#I0657	650	117	440	0.63	215	255
DKTFM2*#I0657	650	117	440	0.55	225	265
DKTFM1*#I0787	780	117	515	0.57	250	255
DKTFM2*#I0787	780	117	515	0.49	260	310
DKTFM3*#I8356	835	165	365	1.03	180	210
DKTFM4*#I8356	835	165	365	0.94	185	215
DKTFM1*#I0917	910	117	590	0.53	255	255
DKTFM2*#I0917	910	117	590	0.45	295	355
DKTFM3*#I1047	1040	165	440	0.88	215	250
DKTFM4*#I1047	1040	165	440	0.79	220	255
DKTFM1*#I1107	1100	117	705	0.48	255	255
DKTFM2*#I1107	1100	117	705	0.40	350	400
DKTFM3*#I1257	1250	165	515	0.78	245	255
DKTFM4*#I1257	1250	165	515	0.69	255	295
DKTFM1*#I1307	1300	117	815	0.45	255	255
DKTFM2*#I1307	1300	117	815	0.37	400	400
DKTFM3*#I1467	1460	165	590	0.71	255	255
DKTFM4*#I1467	1460	165	590	0.62	290	335
DKTFM3*#I1787	1780	165	705	0.64	255	255
DKTFM4*#I1787	1780	165	705	0.55	340	395
DKTFM3*#I2087	2080	165	815	0.60	255	255
DKTFM4*#I2087	2080	165	815	0.51	385	400

\* Insert terminal type (1, 2, 3 or 4) # Insert **W** (without) or **M** (brackets) for fixing

# TRAFIM PRODUCTS

1950Vdc to 6000Vdc

## RATINGS AND PART NUMBER REFERENCE

Un = 4700Vdc						
Part Number	Capacitance (µF)	Width (mm)	Height (mm)	R <sub>s</sub> (mΩ)	I <sub>rms</sub> thermal 1 (A)	I <sub>rms</sub> thermal 2 (A)
DKTFM1*#J2056	205	117	215	0.77	100	120
DKTFM2*#J2056	205	117	215	0.69	105	125
DKTFM1*#J0317	310	117	290	0.58	140	170
DKTFM2*#J0317	310	117	290	0.50	145	175
DKTFM3*#J3356	335	165	215	1.08	115	130
DKTFM4*#J3356	335	165	215	0.99	120	135
DKTFM1*#J0417	410	117	365	0.49	180	220
DKTFM2*#J0417	410	117	365	0.41	185	225
DKTFM3*#J5056	505	165	290	0.80	155	180
DKTFM4*#J5056	505	165	290	0.71	160	185
DKTFM1*#J5156	515	117	440	0.44	220	255
DKTFM2*#J5156	515	117	440	0.36	225	270
DKTFM1*#J6156	615	117	515	0.41	255	255
DKTFM2*#J6156	615	117	515	0.33	260	315
DKTFM3*#J0677	670	165	365	0.66	195	225
DKTFM4*#J0677	670	165	365	0.57	200	235
DKTFM1*#J0727	720	117	590	0.38	255	255
DKTFM2*#J0727	720	117	590	0.30	300	355
DKTFM3*#J0847	840	165	440	0.58	230	255
DKTFM4*#J0847	840	165	440	0.49	240	280
DKTFM1*#J8756	875	117	705	0.36	255	255
DKTFM2*#J8756	875	117	705	0.28	350	400
DKTFM3*#J1007	1000	165	515	0.54	255	255
DKTFM4*#J1007	1000	165	515	0.44	280	320
DKTFM1*#J1037	1030	117	815	0.35	255	255
DKTFM2*#J1037	1030	117	815	0.27	400	400
DKTFM3*#J1177	1170	165	590	0.50	255	255
DKTFM4*#J1177	1170	165	590	0.41	315	365
DKTFM3*#J1427	1420	165	705	0.47	255	255
DKTFM4*#J1427	1420	165	705	0.38	365	400
DKTFM3*#J1687	1680	165	815	0.45	255	255
DKTFM4*#J1687	1680	165	815	0.36	400	400

\* Insert terminal type (1, 2, 3 or 4) # Insert **W** (without) or **M** (brackets) for fixing

# TRAFIM PRODUCTS

1950Vdc to 6000Vdc

## RATINGS AND PART NUMBER REFERENCE

Un = 5200Vdc						
Part Number	Capacitance (µF)	Width (mm)	Height (mm)	R <sub>s</sub> (mΩ)	I <sub>rms</sub> thermal 1 (A)	I <sub>rms</sub> thermal 2 (A)
DKTFM1*#K0167	160	117	215	0.85	90	110
DKTFM2*#K0167	160	117	215	0.77	95	115
DKTFM1*#K0247	240	117	290	0.63	125	150
DKTFM2*#K0247	240	117	290	0.55	130	155
DKTFM3*#K2656	265	165	215	1.18	105	120
DKTFM4*#K2656	265	165	215	1.09	110	125
DKTFM1*#K3156	315	117	365	0.53	160	195
DKTFM2*#K3156	315	117	365	0.45	165	200
DKTFM3*#K3956	395	165	290	0.87	145	165
DKTFM4*#K3956	395	165	290	0.78	150	170
DKTFM1*#K3956	395	117	440	0.47	195	235
DKTFM2*#K3956	395	117	440	0.39	200	240
DKTFM1*#K4756	475	117	515	0.43	230	255
DKTFM2*#K4756	475	117	515	0.35	235	280
DKTFM3*#K5256	525	165	365	0.72	180	205
DKTFM4*#K5256	525	165	365	0.63	185	210
DKTFM1*#K0557	550	117	590	0.41	255	255
DKTFM2*#K0557	550	117	590	0.33	270	320
DKTFM3*#K6556	655	165	440	0.63	210	245
DKTFM4*#K6556	655	165	440	0.54	220	255
DKTFM1*#K6756	675	117	705	0.38	255	255
DKTFM2*#K6756	675	117	705	0.30	315	380
DKTFM3*#K7856	785	165	515	0.57	245	255
DKTFM4*#K7856	785	165	515	0.48	255	295
DKTFM1*#K0797	790	117	815	0.37	255	255
DKTFM2*#K0797	790	117	815	0.29	360	400
DKTFM3*#K9156	915	165	590	0.53	255	255
DKTFM4*#K9156	915	165	590	0.44	290	335
DKTFM3*#K1117	1110	165	705	0.50	255	255
DKTFM4*#K1117	1110	165	705	0.40	335	390
DKTFM3*#K1307	1300	165	815	0.47	255	255
DKTFM4*#K1307	1300	165	815	0.38	380	400

\* Insert terminal type (1, 2, 3 or 4) # Insert **W** (without) or **M** (brackets) for fixing

# TRAFIM PRODUCTS

1950Vdc to 6000Vdc

## RATINGS AND PART NUMBER REFERENCE

Un = 5800Vdc						
Part Number	Capacitance (μF)	Width (mm)	Height (mm)	R <sub>s</sub> (mΩ)	I <sub>rms</sub> thermal 1 (A)	I <sub>rms</sub> thermal 2 (A)
DKTFM1*#L0137	130	117	215	0.91	80	100
DKTFM2*#L0137	130	117	215	0.83	85	105
DKTFM1*#L1956	195	117	290	0.68	115	140
DKTFM2*#L1956	195	117	290	0.60	120	145
DKTFM3*#L2156	215	165	215	1.29	95	110
DKTFM4*#L2156	215	165	215	1.20	100	115
DKTFM1*#L0267	260	117	365	0.56	150	180
DKTFM2*#L0267	260	117	365	0.48	155	185
DKTFM3*#L3256	325	165	290	0.94	130	150
DKTFM4*#L3256	325	165	290	0.85	135	155
DKTFM1*#L3256	325	117	440	0.50	180	215
DKTFM2*#L3256	325	117	440	0.42	185	220
DKTFM1*#L0397	390	117	515	0.45	210	255
DKTFM2*#L0397	390	117	515	0.37	215	260
DKTFM3*#L4356	435	165	365	0.77	165	190
DKTFM4*#L4356	435	165	365	0.68	170	195
DKTFM1*#L4556	455	117	590	0.43	240	255
DKTFM2*#L4556	455	117	590	0.35	245	295
DKTFM3*#L0547	540	165	440	0.67	200	230
DKTFM4*#L0547	540	165	440	0.58	205	235
DKTFM1*#L5556	555	117	705	0.40	255	255
DKTFM2*#L5556	555	117	705	0.32	295	350
DKTFM3*#L0657	650	165	515	0.61	230	255
DKTFM4*#L0657	650	165	515	0.51	240	275
DKTFM1*#L6556	655	117	815	0.38	255	255
DKTFM2*#L6556	655	117	815	0.30	335	400
DKTFM3*#L7556	755	165	590	0.56	255	255
DKTFM4*#L7556	755	165	590	0.47	270	310
DKTFM3*#L0927	920	165	705	0.52	255	255
DKTFM4*#L0927	920	165	705	0.43	315	365
DKTFM3*#L1087	1080	165	815	0.49	255	255
DKTFM4*#L1087	1080	165	815	0.40	360	400

\* Insert terminal type (1, 2, 3 or 4) # Insert W (without) or M (brackets) for fixing

# TRAFIM PRODUCTS

1950Vdc to 6000Vdc

## RATINGS AND PART NUMBER REFERENCE

Un = 6000Vdc						
Part Number	Capacitance (µF)	Width (mm)	Height (mm)	R <sub>s</sub> (mΩ)	I <sub>rms</sub> thermal 1 (A)	I <sub>rms</sub> thermal 2 (A)
DKTFM1*#M0117	110	117	215	0,98	75	90
DKTFM2*#M0117	110	117	215	0,90	80	95
DKTFM1*#M1656	165	117	290	0,72	105	130
DKTFM2*#M1656	165	117	290	0,64	110	135
DKTFM3*#M0187	180	165	215	1,39	85	100
DKTFM4*#M0187	180	165	215	1,30	90	105
DKTFM1*#M0227	220	117	365	0,59	135	165
DKTFM2*#M0227	220	117	365	0,51	140	170
DKTFM3*#M0277	270	165	290	1,01	120	140
DKTFM4*#M0277	270	165	290	0,92	125	145
DKTFM1*#M2756	275	117	440	0,52	165	200
DKTFM2*#M2756	275	117	440	0,44	170	205
DKTFM1*#M0337	330	117	515	0,48	195	235
DKTFM2*#M0337	330	117	515	0,40	200	240
DKTFM3*#M3656	365	165	365	0,82	155	180
DKTFM4*#M3656	365	165	365	0,73	160	185
DKTFM1*#M3856	385	117	590	0,45	225	255
DKTFM2*#M3856	385	117	590	0,37	230	275
DKTFM3*#M4556	455	165	440	0,71	185	215
DKTFM4*#M4556	455	165	440	0,62	190	220
DKTFM1*#M4656	465	117	705	0,41	255	255
DKTFM2*#M4656	465	117	705	0,33	275	325
DKTFM3*#M5456	545	165	515	0,64	215	250
DKTFM4*#M5456	545	165	515	0,55	220	255
DKTFM1*#M0557	550	117	815	0,39	255	255
DKTFM2*#M0557	550	117	815	0,31	315	375
DKTFM3*#M6356	635	165	590	0,59	245	255
DKTFM4*#M6356	635	165	590	0,50	250	290
DKTFM3*#M7756	775	165	705	0,54	255	255
DKTFM4*#M7756	775	165	705	0,45	295	345
DKTFM3*#M0917	910	165	815	0,51	255	255
DKTFM4*#M0917	910	165	815	0,42	340	390

\* Insert terminal type (1, 2, 3 or 4) # Insert **W** (without) or **M** (brackets) for fixing

# TRAFIM PRODUCTS

1950Vdc to 6000Vdc

## CALCULATION FORM

### Specification

Capacitance	C (μF)	
Working voltage	U <sub>w</sub> (V)	
Rms current	I <sub>rms</sub> (A <sub>rms</sub> )	
Frequency	f (Hz)	
Ripple voltage	U <sub>r</sub> (V)	
Ambient temperature	θ <sub>amb</sub> (°C)	
Lifetime @ V <sub>w</sub> , I <sub>rms</sub> and θ <sub>amb</sub>	hours	
Parasitic inductance	L (nH)	
Cooling conditions		

### Your Choice

PN		
Capacitance	C (μF)	
Rated voltage	U <sub>n</sub> (V)	
Serial resistance	R <sub>s</sub> (mΩ)	
Thermal resistance between hot spot and case	R <sub>th1</sub> (°C/W)	
Thermal resistance between case and ambient air	R <sub>th2</sub> (°C/W)	

### Calculations

Maximum ripple voltage	U <sub>rmax</sub> = 0.45U <sub>n</sub>	U <sub>rmax</sub> =	V
------------------------	--	---------------------	---

The maximum ripple voltage of the selected capacitor must be in any case higher than the ripple voltage of your application

Ratio U <sub>w</sub> /U <sub>n</sub>	ρ = U <sub>w</sub> /U <sub>n</sub>	ρ =	
Joule losses	P <sub>j</sub> = R <sub>s</sub> × I <sub>rms</sub> <sup>2</sup>	P <sub>j</sub> =	W
Dielectric losses	P <sub>d</sub> = Q × tgδ <sub>n</sub> = Q × 3.10 <sup>-4</sup>	P <sub>d</sub> =	W
Hot spot temperature	θ <sub>HS</sub> = θ <sub>amb</sub> + (P <sub>j</sub> + P <sub>d</sub> ) × (R <sub>th1</sub> + R <sub>th2</sub> )	θ <sub>HS</sub> =	°C

The hot spot temperature must be in any case lower than 85°C

## LIFETIME EXPECTANCY VS HOT SPOT TEMPERATURE AND VOLTAGE

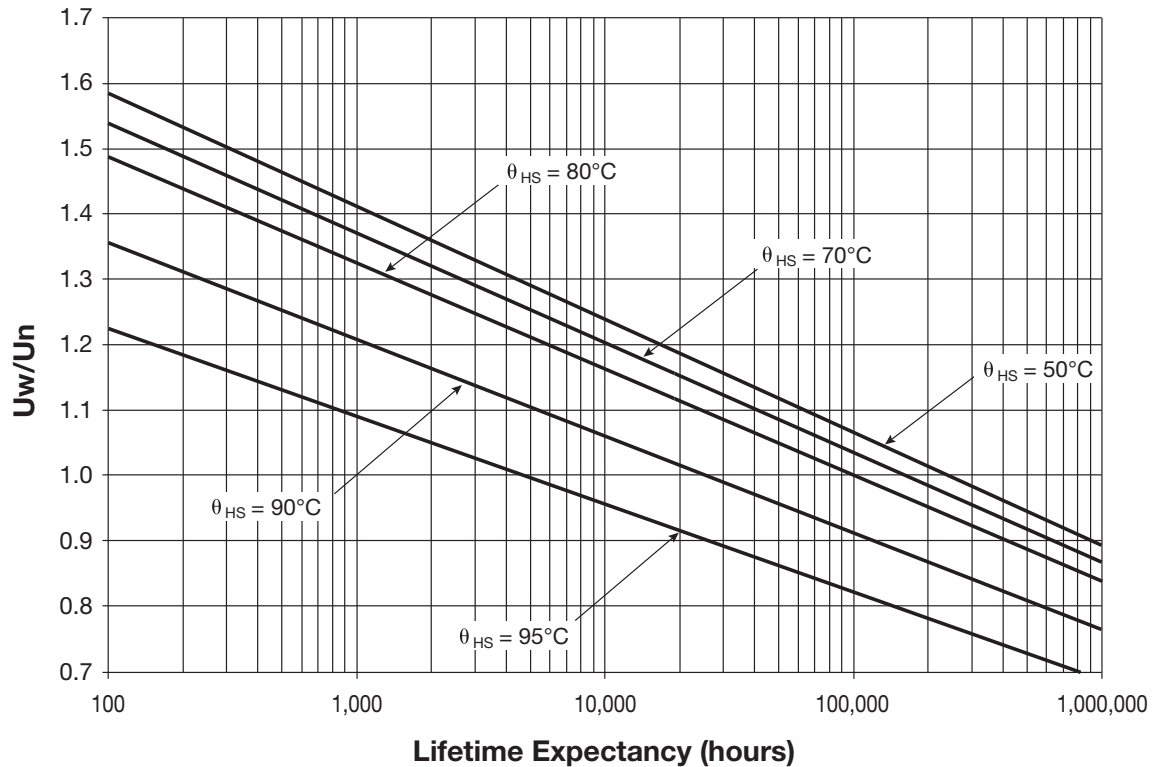

Expected lifetime at hot spot calculated and  $U = U_w$

# TRAFIM PRODUCTS

## 1950Vdc to 6000Vdc

This questionnaire lists the information we require to prepare an offer according to your exact requirements

Company / Name / Email	Project / Quantity
------------------------	--------------------

Applications	DC Filtering		Discharge*		Protection*		Tuning
Capacitance (µF)							
Tolerance (%)							
Operating Voltage	Vpeak		Vch		Vpeak	Vdc	Vrms
Ripple Voltage (peak to peak)	V						
Working Frequency (Hz)							
Operating Current	Arms		Apeak		Arms		Arms
Maximum Current/Duration	Arms	s			Apeak		
Discharge			Aperiodic	Oscillatory			
Pulse Duration (5% Ipeak)							
Time to Ipeak (µs)							
Ringing Frequency (Hz)							
Reversal Voltage (%)							
Repetition Rate			shots/min/hour/day		Hz		
Hold Time @ Full Voltage (s)							
Fault Peak Current / nb shots	Apeak	shots	Apeak	shots			
Fault Reversal Voltage (%)							
Lifetime Expectancy	hours		shots		hours		hours
Maximum Inductance (nH)							
Test Voltage between Terminals (V)							
Test Voltage between Shorted Terminals and Case (V)							
Maximum Surge Voltage (MSV)							
MSV Duration / Frequency	s	/year			s	/year	

\*Due to the particularities of varying waveforms in such application, more information on the exact nature of waveform is generally required for a full analysis.

Description			
Dimensions (mm) / Shape		Operating Position	Terminals
Section:	Height:	vertical, horizontal inclined, upside down	type
rectangular, cylindrical			quantity

Thermal Characteristics				
Storage Temperature (°C)		Operating Temperature (°C)		Cooling Method
min.		min.		Natural Convection
average		average		Forced Air (m/s)
max.		max.		Water

<b>Remarks</b>
----------------

# FILFIM PRODUCTS

6500Vdc to 56000Vdc



## GENERAL DESCRIPTION

The FILFIM series is specifically designed for DC filtering applications for voltages up to 56000V.

Large case sizes up to 100 liters and high specific energy up to 250J/l together with safe and reliable **Controlled Self Healing Technology** make this series particularly suitable for power converters in energy and power transmission areas, active correction and high power DC supply.

The **Controlled Self Healing Technology** is based on a high temperature grade metallized film impregnated with vegetable oil allowing operating temperature up to 85°C.

Standard designs proposed in this catalogue are covering a wide range of voltage and capacitance values.

In case of specific requirements about shape and performances, feel free to contact your local KYOCERA AVX representative.

## PACKAGING MATERIAL

non-painted  
with or without fixing brackets  
grounding via a nut on the top of the case  
3 terminal sizes vs voltage  
1 or 2 terminals

## STANDARDS

IEC 61071: Power electronic capacitors  
IEC 60068-2: Environmental testing

## HOW TO ORDER

<b>DK</b>	<b>IFM</b>	<b>1</b>	<b>B</b>	<b>M</b>	<b>B</b>	<b>0306</b>
	Series	Section and Option	Terminals Type	Fixing	Voltage	Capacitance EIA code
		1 = 350x185 1 terminal 2 = 350x185 2 terminals 3 = 520x185 1 terminal 4 = 520x185 2 terminals 5 = 695x185 1 terminal 6 = 695x185 2 terminals	A, B or C See drawings	W = without M = brackets	A = 6500V B = 7900V C = 9000V D = 10500V E = 12000V F = 14500V G = 15800V H = 18000V I = 22000V J = 26000V K = 28000V L = 32000V M = 36000V N = 42000V O = 56000V	



# FILFIM PRODUCTS

## 6500Vdc to 56000Vdc

### DEFINITIONS

$C_n$ ( $\mu\text{F}$ )	capacitance	nominal value of the capacitance measured at $\theta_{\text{amb}} = 25^\circ\text{C} \pm 10^\circ\text{C}$
$U_n$ (V)	rated DC voltage	maximum operating peak voltage of either polarity (non-reversing type waveform), for which the capacitor has been designed for continuous operation
$U_w$ (V)	working voltage	value of the maximum operating recurrent voltage for a given hot spot temperature and an expected lifetime
$U_r$ (V)	ripple voltage	peak-to-peak alternating component of the unidirectional voltage
$L_s$ (nH)	parasitic inductance	capacitor series self-inductance
$R_s$ (m $\Omega$ )	series resistance	capacitor series resistance due to galvanic circuit
$I_{\text{rms}}$ (A) $I_{\text{max}}$ (A)	RMS current	Maximum rms current value @ 100Hz for continuous operation
$\theta_{\text{amb}}$ ( $^\circ\text{C}$ )	cooling air temperature	temperature of the cooling air measured at the hottest position of the capacitor, under steady-state conditions, midway between two units NOTE If only one unit is involved, it is the temperature measured at a point approximately 0.1 m away from the capacitor container and at two-thirds of the height from its base
$\theta_{\text{HS}}$ ( $^\circ\text{C}$ )	hot spot temperature	highest temperature obtained inside the case of the capacitor in thermal equilibrium

### CHARACTERISTICS

Capacitance range $C_n$	2.6 $\mu\text{F}$ to 612 $\mu\text{F}$
Tolerance on $C_n$	$\pm 10\%$
Rated DC voltage $U_n$	6500 to 56000V (100kV on specific design)
Lifetime at $U_n$ and 80 $^\circ\text{C}$ hot-spot temperature and $\Delta C / C < 2\%$	100,000h
Parasitic inductance $L_s$	250nH to 830nH
Maximum rms current $I_{\text{rms}}$	up to 120A $_{\text{rms}}$
Test voltage between terminals @ 25 $^\circ\text{C}$	1.5 x $U_n$ for 10s
Test voltage between terminals and Case @ 25 $^\circ\text{C}$	1.5 x $U_n$ for 10s
Dielectric	Polypropylene
Climatic Category	55 / 85 / 56 (IEC 60068)
Working temperature	-55 $^\circ\text{C}$ / +85 $^\circ\text{C}$ (according to the power dissipated)
Storage temperature	-55 $^\circ\text{C}$ / +85 $^\circ\text{C}$
Calorific value	30 MJ/kg

### LIFETIME EXPECTANCY VS HOT SPOT TEMPERATURE AND VOLTAGE

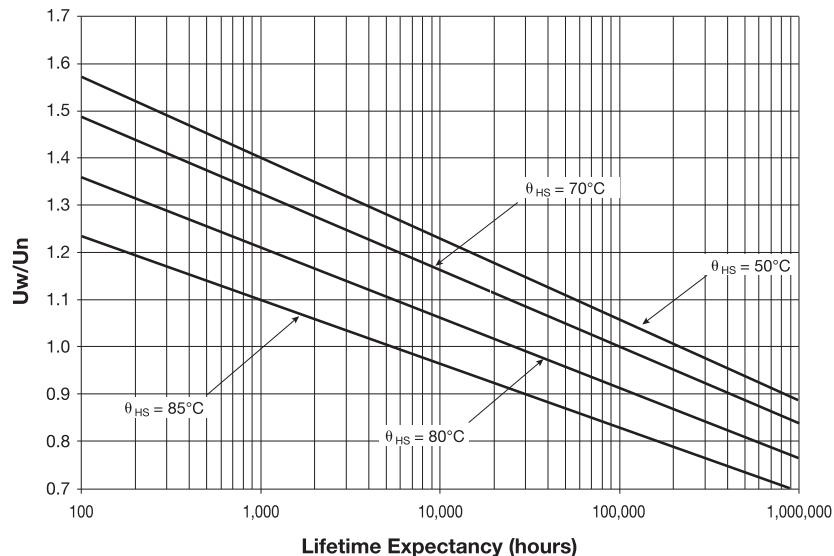

# FILFIM PRODUCTS

## 6500Vdc to 56000Vdc

### HOW TO CHOSE THE RIGHT CAPACITOR

The capacitor lifetime depends on the working voltage and the hot spot temperature.

Our caps are designed to meet 100,000 hours lifetime at rated voltage and 70°C hot spot temperature. In accordance with operating conditions, please calculate the hot spot temperature and deduce from this calculation if the obtained lifetime can suit the application.

#### 1. From the tables, select a capacitor with required capacitance $C_n$ and voltage $U_n$ .

Calculate the maximum ripple voltage allowed for the selected cap:

$$U_{rmax} = 0.2U_n$$

If  $U_r > U_{rmax}$ , select a capacitor with higher rated voltage or contact your local sales representative

Make sure  $I_{rms}$  application  $<$   $I_{rms}$  table

Copy out:

- serial resistance ( $R_s$ ): see table of values
- thermal resistances  $R_{th1}$  and  $R_{th2}$

#### 2. Hot spot temperature calculation

Total losses are calculated as follow:  $P_t = P_j + P_d$

Joule losses:  $P_j = R_s \times I_{rms}^2$

Dielectric losses:  $P_d = Q \times \text{tg}\delta_0$  with

- $Q$  (reactive power) =  $\frac{I_{rms}^2}{C}$  for a sinusoidal waveform
- $\text{tg}\delta_0 = 3 \times 10^{-4}$  (dielectric losses of polypropylene + oil)

Hot spot temperature will be:

$$\theta_{HS} = \theta_{amb} + (P_j + P_d) \times (R_{th1} + R_{th2})$$

$\theta_{HS}$  **absolute maximum is 85°C**

If temperature is higher than 85°C, come back to #1 and start again with another selection.

$R_{th1}$ : thermal resistance between hot spot and case

$R_{th2}$ : thermal resistance between case and ambient air

#### 3. Refer to the curve and deduce the lifetime vs $U_w/U_n$ ratio

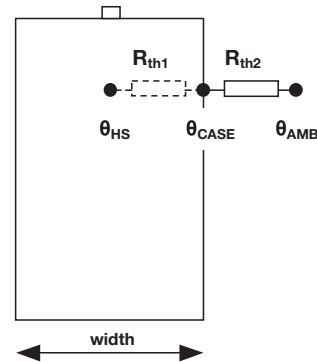
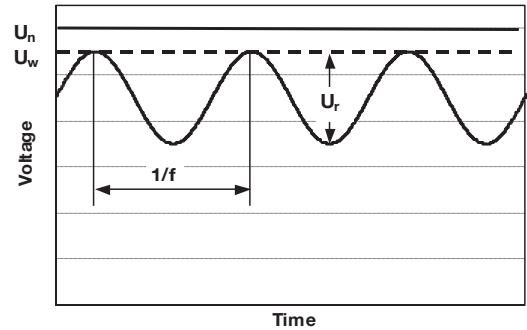
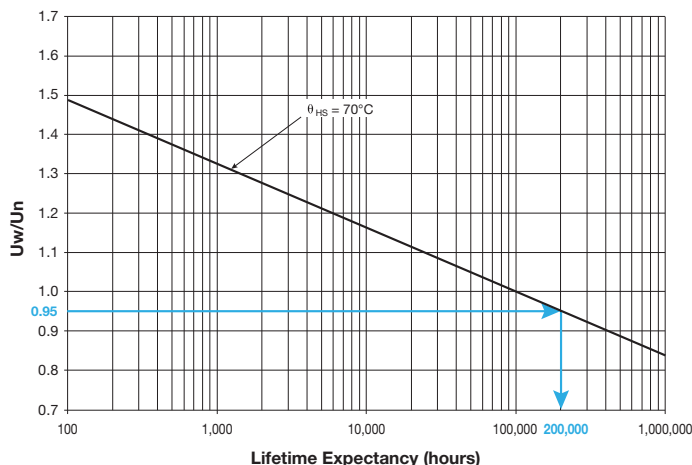

eg: rated voltage 12000V  
 working voltage 11400V  
 $\rho = 0.95 \Rightarrow$  lifetime 200,000 hours  
 @ 70°C hot spot temperature  
 Please, find a calculation form at the end of the catalog

# FILFIM PRODUCTS

6500Vdc to 56000Vdc

## THERMAL RESISTANCES

$R_{th1}$  (°C/W): Thermal resistance between hot spot and case

$R_{th2}$  (°C/W): Thermal resistance between case and ambient air under natural convection and forced air

Height (mm)	$R_{th1}$ (°C/W)			$R_{th2}$ (°C/W)		
	Section (LxW)			Section (LxW)		
	350x185	520x185	695x185	350x185	520x185	695x185
315	0.2	0.15	0.115	0.2	0.15	0.115
410	0.16	0.12	0.095	0.16	0.12	0.095
500	0.14	0.1	0.08	0.14	0.1	0.08
595	0.12	0.085	0.07	0.12	0.085	0.07
685	0.1	0.075	0.06	0.1	0.075	0.06
770	0.09	0.07	0.055	0.09	0.07	0.055



For confined area, capacitor working in a closed cabinet, a thermal test under real conditions is necessary to evaluate the thermal resistance.

## PARASITIC INDUCTANCE VS SIZE

Discharge method measurement

$L_s (nH) = 0.332 \times \text{Height (mm)} + L_{\text{terminal}} \times \text{terminal qty}$

## WEIGHT VS SIZE

Height (mm)	Weight (kg)		
	Section 350x185	Seccttioon 520x185	Section 695x185
315	29	41	54
410	36	52	68
500	43	62	81
595	50	72	95
685	57	82	108
770	63	91	119

# FILFIM PRODUCTS

## 6500Vdc to 56000Vdc

### MTBF CALCULATION

The failure rate  $\lambda_B$  depends on hot spot temperature  $\theta_{HS}$  and charge ratio  $\rho$ .

$$\rho = U_w/U_n$$

$$\lambda_B = 3 \times 10^{5,738(\rho-1)} \times e^{\left(3,933 \left(\frac{\theta_{HS}+273}{368}\right)^{27,75}\right)} \times 10^{-9} \text{ in failures/hour}$$

### GENERAL FAILURE RATE

$\lambda = \lambda_B \times \pi_Q \times \pi_B \times \pi_E$  failures/hour •  $\pi_Q$ ,  $\pi_B$  and  $\pi_E$  see following tables

Qualification	Qualification factor $\pi_Q$
Product qualified on IEC61071 or IEC61881 and internal qualification	1
Product qualified on IEC61071 or IEC61881	2
Product answering on another norm	5
Product without qualification	15

Environment	Environment factor $\pi_E$
On ground (good conditions)	1
On ground (fixed materials)	2
On ground (on board)	4
On ship	9
On plane	15

Environment	Environment factor $\pi_B$
Favorable	1
Unfavourable	5

### MEAN TIME BETWEEN FAILURE (MTBF)

$$MTBF = 1/\lambda \text{ hours}$$

### SURVIVAL FUNCTION

$$N = N_0 \times \exp(-\lambda t)$$

N is the number of pieces still working after t hours.

$N_0$  is the number of pieces at the origin (t = 0)

### FAILURE MODE

Main failure mode due to KYOCERA AVX's **Controlled Self-Healing Technology** is only losses of capacitance. Thanks to the **Controlled Self-Healing Technology**, the efficient solution to interrupt the self-healing process and prevent the avalanche effect leading to the worse sequence of events for none controlled self-healing capacitors: polypropylene molecular cracking, gas emission and potential explosion in confined box.

# FILFIM PRODUCTS

6500Vdc to 56000Vdc

## DIMENSIONS

### 1 TERMINAL

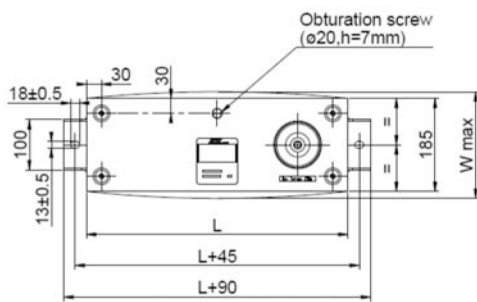
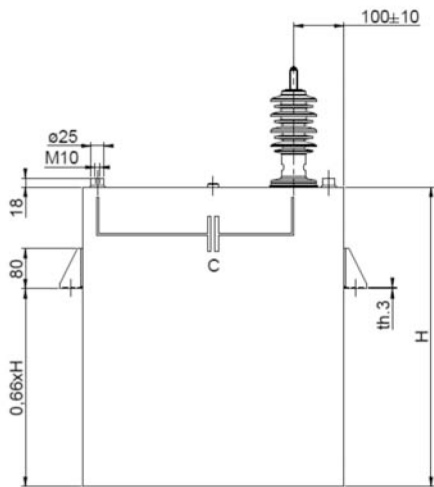

### 2 TERMINALS

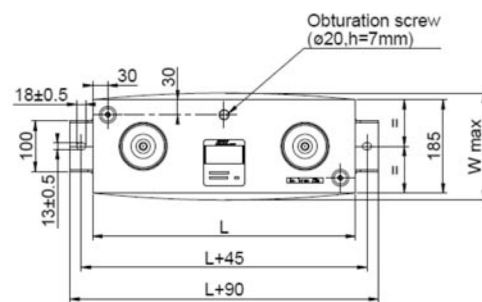
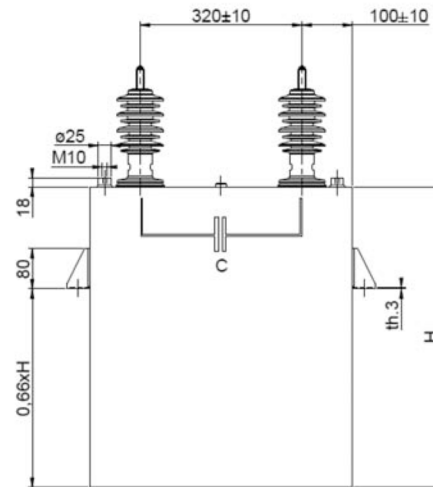

L	≥520mm	<520mm
Wmax	215mm	205mm

## TERMINALS

**Type A**  $U_n \leq 16kV$   
 $L=140nH$   
 max torque 25Nm

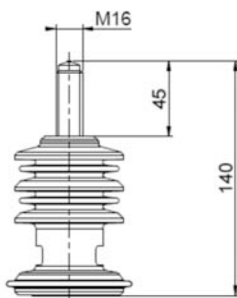

**Type B**  $16kV < U_n \leq 32kV$   
 $L=240nH$   
 max torque 25Nm

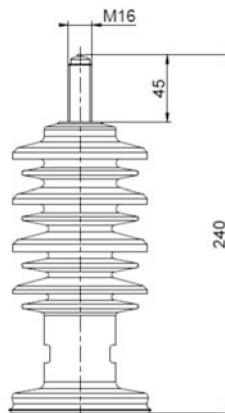

**Type C**  $32kV < U_n \leq 56kV$   
 $L=285nH$   
 max torque 25Nm

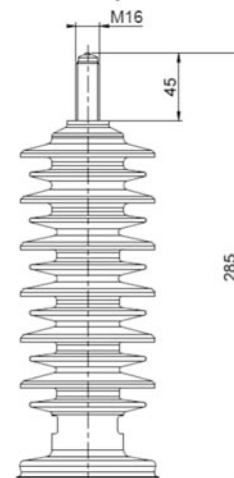

# FILFIM PRODUCTS

6500Vdc to 56000Vdc

## RATINGS AND PART NUMBER REFERENCE

Part Number	Capacitance (µF)	Height (mm)	R <sub>s</sub> (mΩ)	I <sub>rms</sub> max (A)
<b>Un = 6500Vdc Terminal type A Section 350x185 (LxW)</b>				
DLIFM*A#A1886	188	315	3.4	90
DLIFM*A#A2756	275	410	3.3	110
DLIFM*A#A3626	362	500	3.2	120
DLIFM*A#A0457	450	595	3.2	120
DLIFM*A#A5376	537	685	3.1	120
DLIFM*A#A6126	612	770	3.1	120
<b>Un = 7900Vdc Terminal type A Section 350x185 (LxW)</b>				
DLIFM*A#B1266	126	315	3.6	81
DLIFM*A#B1846	184	410	3.4	100
DLIFM*A#B2426	242	500	3.3	115
DLIFM*A#B0307	300	595	3.2	120
DLIFM*A#B3596	359	685	3.2	120
DLIFM*A#B0417	410	770	3.2	120
<b>Un = 9000Vdc Terminal type A Section 350x185 (LxW)</b>				
DLIFM*A#C0956	95	315	3.7	72
DLIFM*A#C1386	138	410	3.4	95
DLIFM*A#C1816	181	500	3.3	110
DLIFM*A#C2256	225	595	3.3	120
DLIFM*A#C2696	269	685	3.2	120
DLIFM*A#C3076	307	770	3.2	120
<b>Un = 10500Vdc Terminal type A Section 350x185 (LxW)</b>				
DLIFM*A#D0736	73	315	5.8	63
DLIFM*A#D1076	107	410	5	80
DLIFM*A#D0147	140	500	4.6	96
DLIFM*A#D1746	174	595	4.4	110
DLIFM*A#D2086	208	685	4.3	120
DLIFM*A#D2376	237	770	4.3	120
<b>Un = 12000Vdc Terminal type A Section 350x185 (LxW)</b>				
DLIFM*A#E0556	55	315	6.2	56
DLIFM*A#E0806	80	410	5.3	74
DLIFM*A#E1056	105	500	4.9	88
DLIFM*A#E0137	130	595	4.6	102
DLIFM*A#E1556	155	685	4.5	114
DLIFM*A#E1776	177	770	4.4	120
<b>Un = 14500Vdc Terminal type A Section 350x185 (LxW)</b>				
DLIFM*A#F3755	37.5	315	5.6	45
DLIFM*A#F0556	55	410	4.9	67
DLIFM*A#F0726	72	500	4.6	81
DLIFM*A#F0896	89	595	4.4	94
DLIFM*A#F1066	106	685	4.3	106
DLIFM*A#F1216	121	770	4.2	115
<b>Un = 15800Vdc Terminal type A Section 350x185 (LxW)</b>				
DLIFM*A#G3155	31.5	315	5.9	41
DLIFM*A#G0466	46	410	5.1	61
DLIFM*A#G6055	60.5	500	4.7	76
DLIFM*A#G0756	75	595	4.5	89
DLIFM*A#G0896	89	685	4.4	100
DLIFM*A#G1026	102	770	4.3	110
<b>Un = 18000Vdc Terminal type B Section 350x185 (LxW)</b>				
DLIFM*B#H1955	19.5	315	7.8	29
DLIFM*B#H0306	30	410	6.5	45
DLIFM*B#H0456	45	500	5.9	67
DLIFM*B#H0516	51	595	5.6	76
DLIFM*B#H0626	62	685	5.4	86
DLIFM*B#H0726	72	770	5.3	96

Part Number	Capacitance (µF)	Height (mm)	R <sub>s</sub> (mΩ)	I <sub>rms</sub> max (A)
<b>Un = 22000Vdc Terminal type B Section 520x185 (LxW)</b>				
DLIFM*B#I0206	20	315	8.9	36
DLIFM*B#I3155	31.5	410	7.2	52
DLIFM*B#I4255	42.5	500	6.6	64
DLIFM*B#I0546	54	595	6.2	76
DLIFM*B#I0656	65	685	6	86
DLIFM*B#I0756	75	770	5.9	94
<b>Un = 26000Vdc Terminal type B Section 520x185 (LxW)</b>				
DLIFM*B#J1425	14.2	315	9.8	30
DLIFM*B#J2255	22.5	410	7.8	46
DLIFM*B#J0306	30	500	7	57
DLIFM*B#J0386	38	595	6.6	67
DLIFM*B#J0466	46	685	6.3	77
DLIFM*B#J0536	53	770	6.2	85
<b>Un = 28000Vdc Terminal type B Section 350x185 (LxW)</b>				
DLIFM*B#K0585	5.8	315	6.8	14
DLIFM*B#K0905	9	410	5.9	22
DLIFM*B#K0126	12	500	5.5	30
DLIFM*B#K1555	15.5	595	5.2	39
DLIFM*B#K1835	18.3	685	5.1	46
DLIFM*B#K2155	21.5	770	5.1	54
<b>Un = 32000Vdc Terminal type B Section 695x185 (LxW)</b>				
DLIFM*B#L1285	12.8	315	11.2	32
DLIFM*B#L0206	20	410	8.8	43
DLIFM*B#L0276	27	500	7.9	54
DLIFM*B#L0346	34	595	7.4	63
DLIFM*B#L0416	41	685	7.1	73
DLIFM*B#L0476	47	770	6.9	80
<b>Un = 36000Vdc Terminal type C Section 695x185 (LxW)</b>				
DLIFM*C#M0905	9	315	13.5	27
DLIFM*C#M1425	14.2	410	10.5	37
DLIFM*C#M1935	19.3	500	9.3	46
DLIFM*C#M2485	24.8	595	8.6	56
DLIFM*C#M0306	30	685	8.2	64
DLIFM*C#M3555	35.5	770	7.9	72
<b>Un = 42000Vdc Terminal type C Section 520x185 (LxW)</b>				
DLIFM*C#N0355	3.5	315	10	13
DLIFM*C#N0565	5.6	410	8	21
DLIFM*C#N0775	7.7	500	7.2	29
DLIFM*C#N0985	9.8	595	6.9	37
DLIFM*C#N0126	12	685	6.7	45
DLIFM*C#N0146	14	770	6.6	52
<b>Un = 56000Vdc Terminal type C Section 695x185 (LxW)</b>				
DLIFM*C#O0265	2.6	315	11.6	13
DLIFM*C#O0425	4.2	410	9.2	21
DLIFM*C#O0575	5.7	500	8.3	28
DLIFM*C#O0735	7.3	595	7.8	34
DLIFM*C#O0885	8.8	685	7.5	40
DLIFM*C#O1035	10.3	770	7.4	45

\* Section 350x185: Insert section and option (1 or 2)

\* Section 520x185: Insert section and option (3 or 4)

\* Section 695x185: Insert section and option (5 or 6)

# Insert **W** (without) or **M** (brackets) for fixing

# FILFIM PRODUCTS

## FILFIM 6500Vdc to 56000Vdc

### CALCULATION FORM

#### Specification

Capacitance	C (μF)	
Working voltage	U <sub>w</sub> (V)	
Rms current	I <sub>rms</sub> (A <sub>rms</sub> )	
Frequency	f (Hz)	
Ripple voltage	U <sub>r</sub> (V)	
Ambient temperature	θ <sub>amb</sub> (°C)	
Lifetime @ V <sub>w</sub> , I <sub>rms</sub> and θ <sub>amb</sub>	hours	
Parasitic inductance	L (nH)	
Cooling conditions		

#### Your Choice

PN		
Capacitance	C (μF)	
Rated voltage	U <sub>n</sub> (V)	
Serial resistance	R <sub>s</sub> (mΩ)	
Thermal resistance between hot spot and case	R <sub>th1</sub> (°C/W)	
Thermal resistance between case and ambient air	R <sub>th2</sub> (°C/W)	

#### Calculations

Maximum ripple voltage	U <sub>rmax</sub> = 0.45U <sub>n</sub>	U <sub>rmax</sub> =	V
------------------------	--	---------------------	---

The maximum ripple voltage of the selected capacitor must be in any case higher than the ripple voltage of your application

Ratio U <sub>w</sub> /U <sub>n</sub>	ρ = U <sub>w</sub> /U <sub>n</sub>	ρ =	
Joule losses	P <sub>j</sub> = R <sub>s</sub> × I <sub>rms</sub> <sup>2</sup>	P <sub>j</sub> =	W
Dielectric losses	P <sub>d</sub> = Q × tgδ <sub>n</sub> = Q × 3.10 <sup>-4</sup>	P <sub>d</sub> =	W
Hot spot temperature	θ <sub>HS</sub> = θ <sub>amb</sub> + (P <sub>j</sub> + P <sub>d</sub> ) × (R <sub>th1</sub> + R <sub>th2</sub> )	θ <sub>HS</sub> =	°C

The hot spot temperature must be in any case lower than 85°C

### LIFETIME EXPECTANCY VS HOT SPOT TEMPERATURE AND VOLTAGE

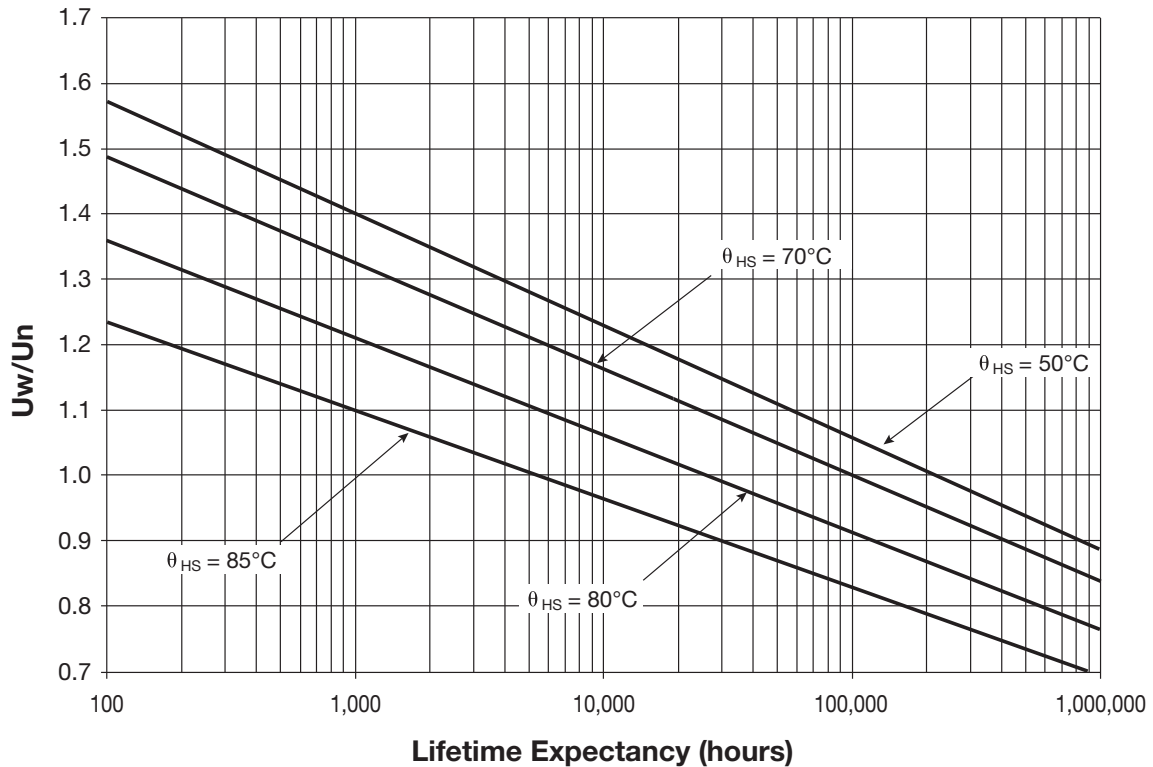

Expected lifetime at hot spot calculated and  $U = U_w$

# FILFIM PRODUCTS

## FILFIM 6500Vdc to 56000Vdc

This questionnaire lists the information we require to prepare an offer according to your exact requirements

Company / Name / Email	Project / Quantity
------------------------	--------------------

Applications	DC Filtering	Discharge*	Protection*	Tuning
Capacitance (µF)				
Tolerance (%)				
Operating Voltage	Vpeak	Vch	Vpeak	Vdc
Ripple Voltage (peak to peak)	V			Vrms
Working Frequency (Hz)				
Operating Current	Arms	Apeak	Arms	Arms
Maximum Current/Duration	Arms	s	Apeak	
Discharge		Aperiodic	Oscillatory	
Pulse Duration (5% Ipeak)				
Time to Ipeak (µs)				
Ringing Frequency (Hz)				
Reversal Voltage (%)				
Repetition Rate		shots/min/hour/day		Hz
Hold Time @ Full Voltage (s)				
Fault Peak Current / nb shots	Apeak	shots	Apeak	shots
Fault Reversal Voltage (%)				
Lifetime Expectancy	hours	shots	hours	hours
Maximum Inductance (nH)				
Test Voltage between Terminals (V)				
Test Voltage between Shorted Terminals and Case (V)				
Maximum Surge Voltage (MSV)				
MSV Duration / Frequency	s	/year	s	/year

\*Due to the particularities of varying waveforms in such application, more information on the exact nature of waveform is generally required for a full analysis.

Description				
Dimensions (mm) / Shape		Operating Position	Terminals	
Section:	Height:	vertical, horizontal inclined, upside down	type	quantity
rectangular, cylindrical				

Thermal Characteristics					
Storage Temperature (°C)		Operating Temperature (°C)		Cooling Method	
min.		min.		Natural Convection	
average		average		Forced Air (m/s)	
max.		max.		Water	

Архангельск (8182)63-90-72  
 Астана (7172)727-132  
 Астрахань (8512)99-46-04  
 Барнаул (3852)73-04-60  
 Белгород (4722)40-23-64  
 Брянск (4832)59-03-52  
 Владивосток (423)249-28-31  
 Волгоград (844)278-03-48  
 Вологда (8172)26-41-59  
 Воронеж (473)204-51-73  
 Екатеринбург (343)384-55-89  
 Иваново (4932)77-34-06

Ижевск (3412)26-03-58  
 Иркутск (395)279-98-46  
 Казань (843)206-01-48  
 Калининград (4012)72-03-81  
 Калуга (4842)92-23-67  
 Кемерово (3842)65-04-62  
 Киров (8332)68-02-04  
 Краснодар (861)203-40-90  
 Красноярск (391)204-63-61  
 Курск (4712)77-13-04  
 Липецк (4742)52-20-81  
 Киргизия (996)312-96-26-47

Магнитогорск (3519)55-03-13  
 Москва (495)268-04-70  
 Мурманск (8152)59-64-93  
 Набережные Челны (8552)20-53-41  
 Нижний Новгород (831)429-08-12  
 Новокузнецк (3843)20-46-81  
 Новосибирск (383)227-86-73  
 Омск (3812)21-46-40  
 Орел (4862)44-53-42  
 Оренбург (3532)37-68-04  
 Пенза (8412)22-31-16  
 Россия (495)268-04-70

Пермь (342)205-81-47  
 Ростов-на-Дону (863)308-18-15  
 Рязань (4912)46-61-64  
 Самара (846)206-03-16  
 Санкт-Петербург (812)309-46-40  
 Саратов (845)249-38-78  
 Севастополь (8692)22-31-93  
 Симферополь (3652)67-13-56  
 Смоленск (4812)29-41-54  
 Сочи (862)225-72-31  
 Ставрополь (8652)20-65-13  
 Казахстан (772)734-952-31

Сургут (3462)77-98-35  
 Тверь (4822)63-31-35  
 Томск (3822)98-41-53  
 Тула (4872)74-02-29  
 Тюмень (3452)66-21-18  
 Ульяновск (8422)24-23-59  
 Уфа (347)229-48-12  
 Хабаровск (4212)92-98-04  
 Челябинск (351)202-03-61  
 Череповец (8202)49-02-64  
 Ярославль (4852)69-52-93

<https://avx.nt-rt.ru/> || [avx@nt-rt](mailto:avx@nt-rt)